



INSTALLATION INSTRUCTIONS

EI (90 cm) models

INSTALLATION INSTRUCTIONS

**Before you start please read the instructions.
Planning your installation will save you time and effort.**

-  **FAILURE TO INSTALL APPLIANCES CORRECTLY IS DANGEROUS AND COULD LEAD TO PROSECUTION.**

-  Installation must be carried out by a qualified installer or engineer. We recommend that the appliance is connected by a competent person who is a member of a “Competent Person Scheme” who will comply with the required regulations.

-  Our policy is one of constant development and improvement, therefore we cannot guarantee the strict accuracy of all of our illustrations and specifications. Changes may have been made subsequent to publishing.

Please keep to the following points most carefully;

-  Although every care has been taken to ensure this appliance has no sharp edges, we recommend that you wear protective gloves when installing and moving this appliance. This will prevent injury.

-  Ensure that you route all mains cables well clear of any adjacent heat source.

-  The space for air circulation, located underneath and at the back of the hob improves its reliability by ensuring that it will cool down, efficiently.

CONTENTS

BEFORE INSTALLATION	4
DIMENSIONS AND CLEARANCES	5
CONNECTION TO THE ELECTRICITY SUPPLY	7
COMMISSIONING	9

BEFORE INSTALLATION

LEVELLING YOUR COOKER

1. Place a spirit level on a baking sheet onto an oven shelf.
2. The cooker is fitted with levelling feet (1). Level your cooker to your desired height using the levelling feet at the front and rear of the cooker.

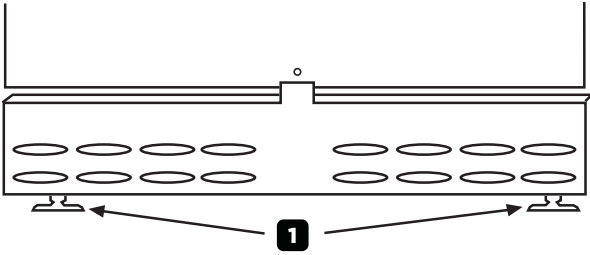

Rear of cooker

REAR WHEELS (IF FITTED)

Adjustment of the wheel height can be made with a screw driver, through the hexagonal hole in the front plinth.

FITTING THE PLINTH (IF APPLICABLE)

1. Ensure the appliance is raised to a height of 915 mm or above using adjusting feet (A) before beginning.
2. Open the appliance doors and loosen screw (C), do not remove the screw entirely. If your appliance has a storage drawer at the bottom, you access the screws through holes located at the base of the drawer after lifting the mat.
3. Fit plinth (B) and secure using screw (C).

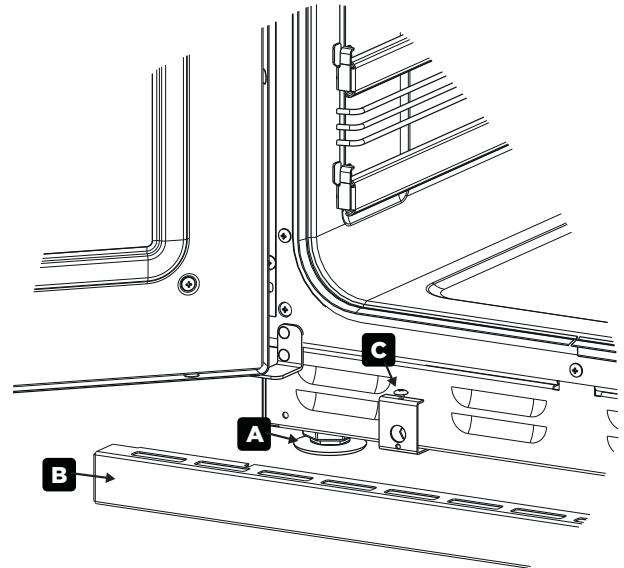

FITTING THE TOWEL RAIL (IF APPLICABLE)

On the towel rail there are two holes, top (A) and bottom (B), these holes have corresponding holes on the fascia at each end.

The 2x longer screws are designed for the top hole (A), whereas the remaining screw just goes through the bottom hole (B). Both screws are M6 screws. Using the Allen key provided, tighten the screws making sure that the towel rail is flush to the fascia, but not over tightened.

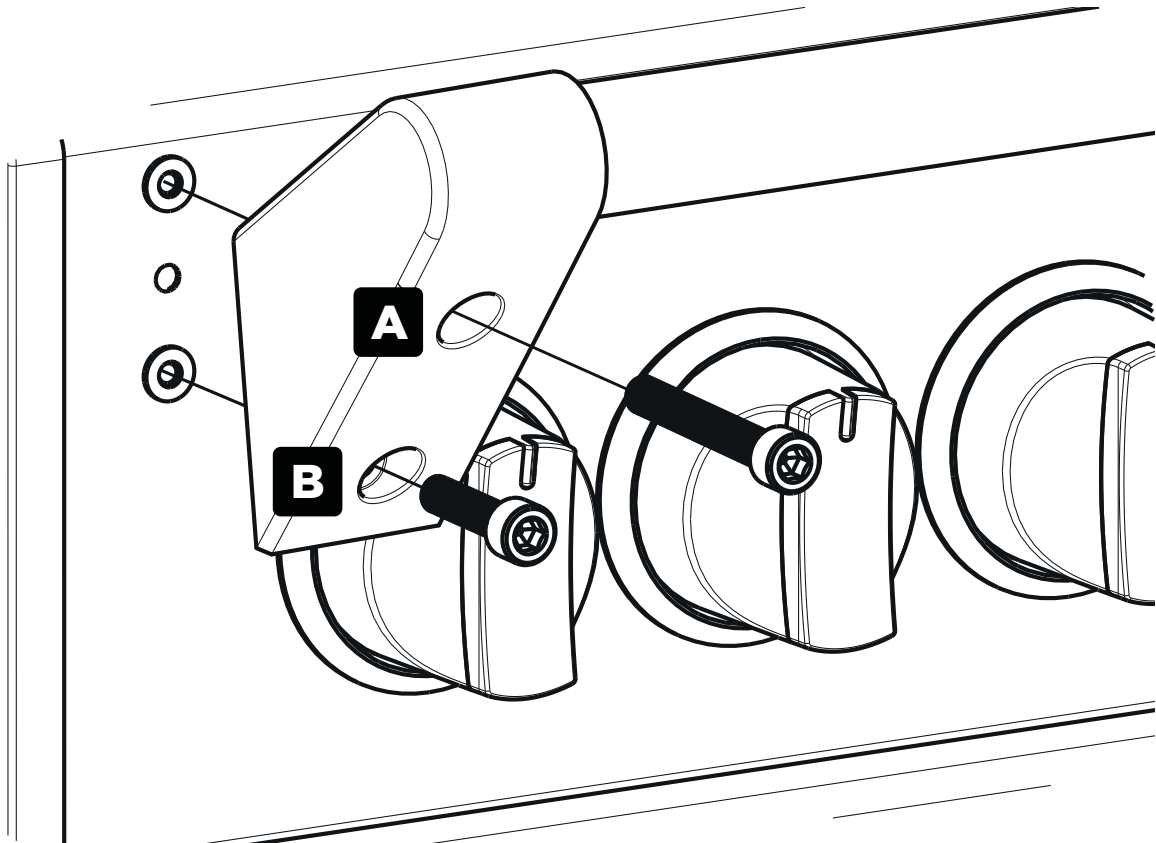

Plinth cover	Stainless	013342453
	Black	013342454

DIMENSIONS AND CLEARANCES



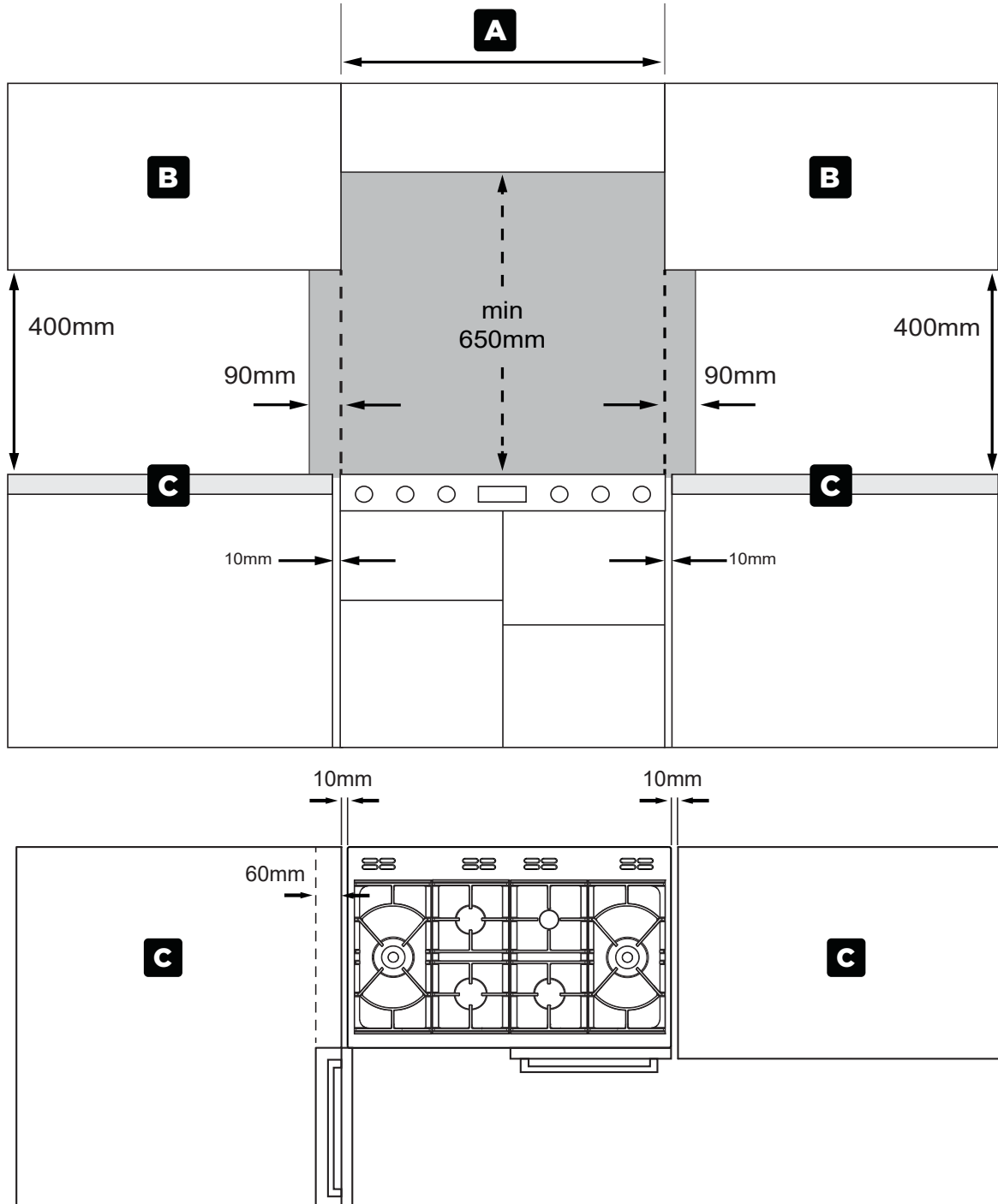

CUPBOARD / HOOD CLEARANCES



A Nominal width of the hob

B Wall Unit

C Worktop

-  No shelf or overhang of combustible material should be closer than 650 mm above the hob.
-  If your appliance has a side opening door, we recommend a side clearance of 60 mm to allow the oven door to fully open, if placed up to a wall or cabinetry.
-  The cooker must have a side clearance above hob level of 90mm up to a height of 400 mm.
-  This cooker may be fitted flush to the base units of your kitchen.

CONNECTION TO THE ELECTRICITY SUPPLY

⚠ WARNING: This appliance must be earthed.

This appliance must be fitted to a switch providing all pole disconnection with a minimum contact separation of 3 mm.

⚠ The terminal block screws and clamps can be damaged by excessive tightening and untightening. **DO NOT USE POWER TOOLS!**

1. Gain access to the mains terminal by removing the terminal block cover at the rear of the appliance.
2. Connection should be made with a suitable flexible cable.
3. First strip the wires then push the cable through the cable clamp.
4. Connect the cable to the terminal block and tighten the cable clamp screws – see diagram.
5. Refit the terminal box cover.
6. Sufficient cable should be used to allow the cooker to be pulled out, but must hang clear of the floor so it does not become twisted or trapped when the cooker is pushed back.

SINGLE PHASE CONNECTION (230 V ~50 HZ)

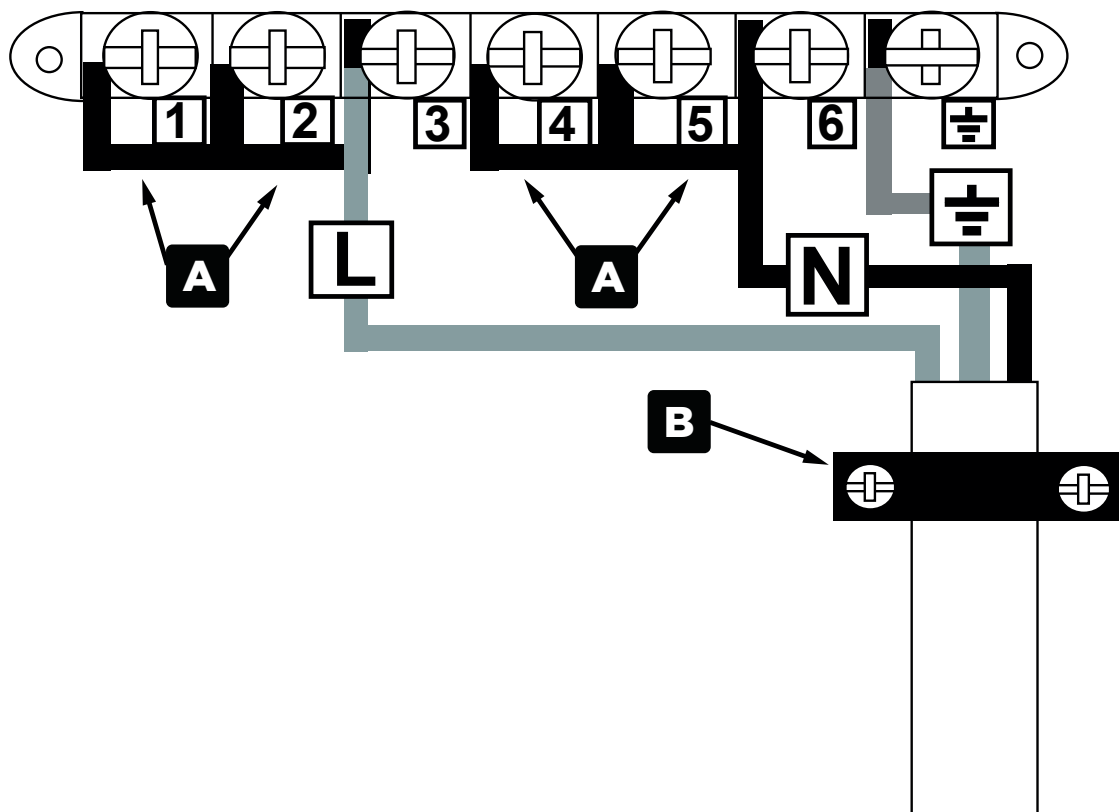

A Shorting Links

B Cable Clamp

7. Connect cable to the terminal block:
 - L to terminal 3
 - N to terminal 6
 - Earth to  terminal

8. Ensure shorting links are fitted between terminals 1-2, 2-3, 4-5 and 5-6.
9. Ensure all screws are fully tightened.

THREE PHASE CONNECTION (230/400 V 3N ~50 HZ)

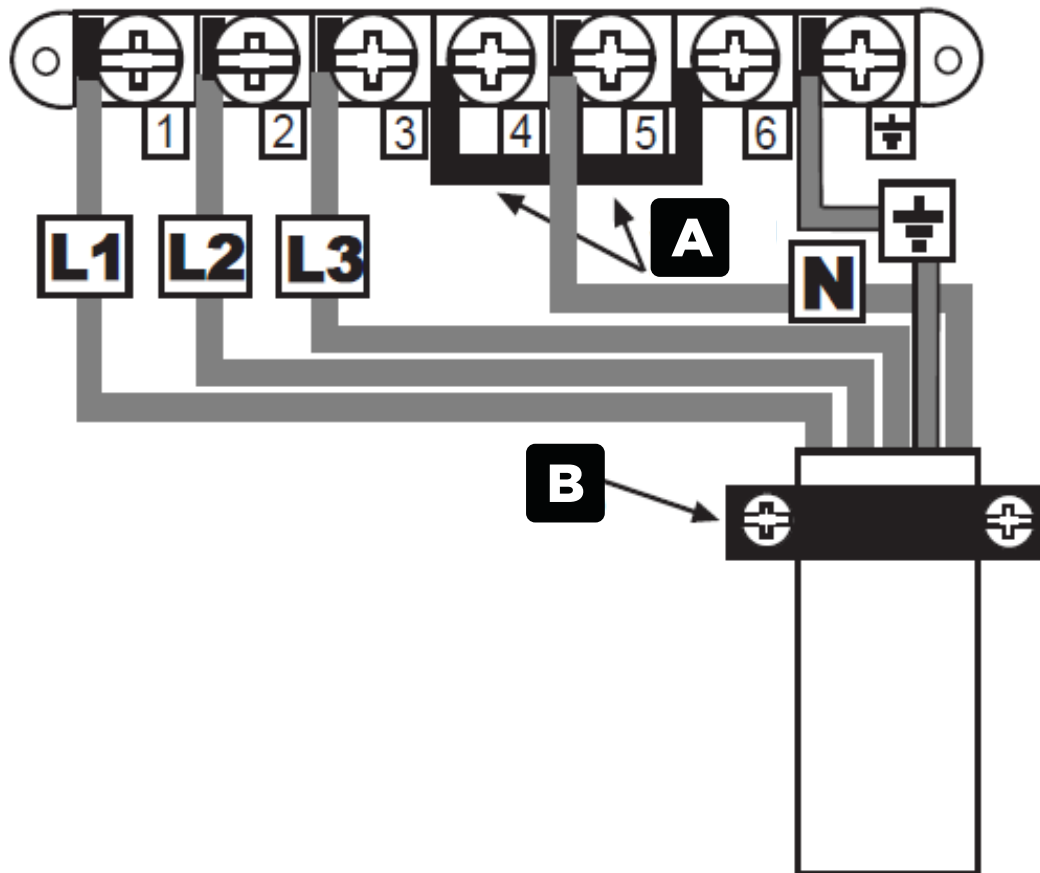

A Shorting Links

B Cable Clamp

7. Connect cable to the terminal block:
 - L1, L2 and L3 to terminals 1, 2 and 3
 - N to terminal 5
 - Earth to \perp terminal
8. Remove shorting links 1-2 and 2-3.
9. Ensure shorting links are fitted between terminals 4-5 and 5-6.
10. Ensure all screws are fully tightened.

COMMISSIONING

CHECK THE OPERATION OF ELECTRICAL COMPONENTS

Clock Programmer/Minute Minder

Check functions as described in the User Guide.

Oven light & Convection fan

Open the main oven door. Turn the main oven control knob to the defrost setting. Check the oven light and convection fan both come on. Turn control knob back to 'OFF' position.

Cooling Fan

Turn the top oven control knob to the full power setting.

Check that the cooling fan operates. Turn control knob back to 'OFF' position and check cooling fan switches off immediately.

i Note: If the cooker does not perform correctly, inform the customer of the problem and put a warning notice on the cooker. If the problem is dangerous, then disconnect the cooker. If there is a fault, then the customer should be advised to contact the manufacturer's local service organisation or the retailer.

i Before leaving the installation hand over the User Guide to the customer

Stoney Lane, Prescot, Merseyside L35 2XW

Product Information Helpline

0344 248 4149