

INSTALLATION INSTRUCTIONS

DF GTG (100/110 cm) models

CONTENTS

REGULATIONS AND STANDARDS	3
BEFORE INSTALLATION	4
DIMENSIONS AND CLEARANCES	6
CONNECTION TO THE ELECTRICITY SUPPLY	8
CONNECT TO THE GAS SUPPLY	10
COMMISSIONING	11

INSTALLATION INSTRUCTIONS

Before you start please read the instructions. Planning your installation will save you time and effort.

 **FAILURE TO INSTALL APPLIANCES CORRECTLY IS DANGEROUS AND COULD LEAD TO PROSECUTION.**

 Installation must be carried out by a qualified installer or engineer. We recommend that the appliance is connected by a competent person who is a member of a “Competent Person Scheme” who will comply with the required regulations.

 Our policy is one of constant development and improvement, therefore we cannot guarantee the strict accuracy of all of our illustrations and specifications. Changes may have been made subsequent to publishing.

Please keep to the following points most carefully;

 Although every care has been taken to ensure this appliance has no sharp edges, we recommend that you wear protective gloves when installing and moving this appliance. This will prevent injury.

 Ensure that you route all mains cables well clear of any adjacent heat source.

 The space for air circulation, located underneath and at the back of the hob improves its reliability by ensuring that it will cool down, efficiently.

REGULATIONS AND STANDARDS

This cooker must be installed in accordance with the instructions in this booklet, the relevant national regulations and with the local gas and electricity supply companies' requirements. Before installation, make sure that the cooker is suitable for your gas type and supply voltage. See the data badge.

This appliance is not connected to a combustion evacuation device. It shall be installed and connected in accordance with current installation regulations. Particular attention shall be given to the relevant requirements regarding ventilation.

In your own interest and that of safety, it is the law that all gas appliances be installed and serviced by competent persons. Failure to install the appliance correctly could invalidate any warranty or liability claims and lead to prosecution.

VENTILATION REQUIREMENTS

The use of a gas cooking appliance results in the production of heat and moisture in the room in which it is installed. Ensure that the kitchen is well ventilated: keep natural ventilation holes open or install a mechanical ventilation device (mechanical extractor hood). Prolonged intensive use of the appliance may call for additional ventilation, for example, opening of a window, or more effective ventilation, for example increasing the level of mechanical ventilation where present.

- The room containing the appliance should have an air supply in accordance with all relevant national regulations and codes of practice in force in the country where it is intended to be installed.
- All rooms require an openable window, or equivalent, and some rooms will also require a permanent vent.
- For room volumes up to 5 m³ an air vent of 100 cm² is required.
- If the room has a door that opens directly to the outside, or the room exceeds 10m³, NO AIR VENT is required.
- For room volumes between 5 m³ and 10 m³ an air vent of 50 cm² is required.
- If there are other fuel burning appliances in the same room, BS 5440-2:2009 should be consulted to determine the air vent requirements.
- This appliance must not be installed in a bed sitting room of less than 20m³ or in a bathroom or shower room.
- Windows and permanent vents should therefore not be blocked or removed without first consulting a qualified installer or engineer.

BEFORE INSTALLATION

LEVELLING YOUR COOKER

1. Place a spirit level on a baking sheet onto an oven shelf.
2. The cooker is fitted with levelling feet (1). Level your cooker to your desired height using the levelling feet at the front and rear of the cooker.

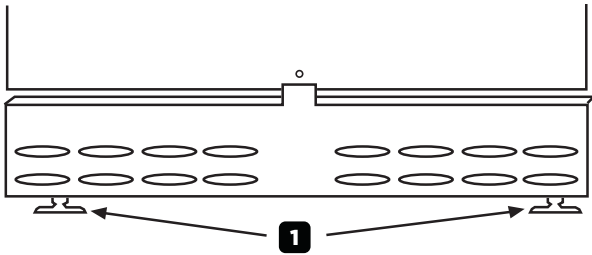

Rear of cooker

REAR WHEELS (IF FITTED)

Adjustment of the wheel height can be made with a screw driver, through the hexagonal hole in the front plinth.

FITTING THE PLINTH (IF APPLICABLE)

1. Ensure the appliance is raised to a height of 915 mm or above using adjusting feet (A) before beginning.
2. Open the appliance doors and loosen screw (C), do not remove the screw entirely. If your appliance has a storage drawer at the bottom, you access the screws through holes located at the base of the drawer after lifting the mat.
3. Fit plinth (B) and secure using screw (C).

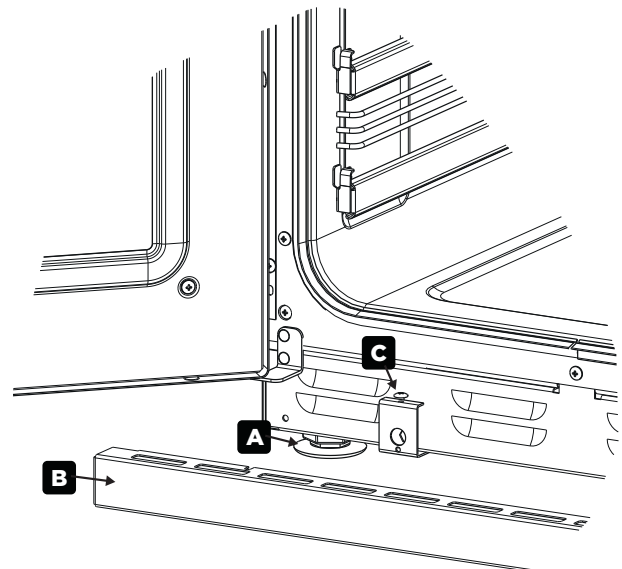

FITTING THE TOWEL RAIL (IF APPLICABLE)

On the towel rail there are two holes, top (A) and bottom (B), these holes have corresponding holes on the fascia at each end.

The 2x longer screws are designed for the top hole (A), whereas the remaining screw just goes through the bottom hole (B). Both screws are M6 screws. Using the Allen key provided, tighten the screws making sure that the towel rail is flush to the fascia, but not over tightened.

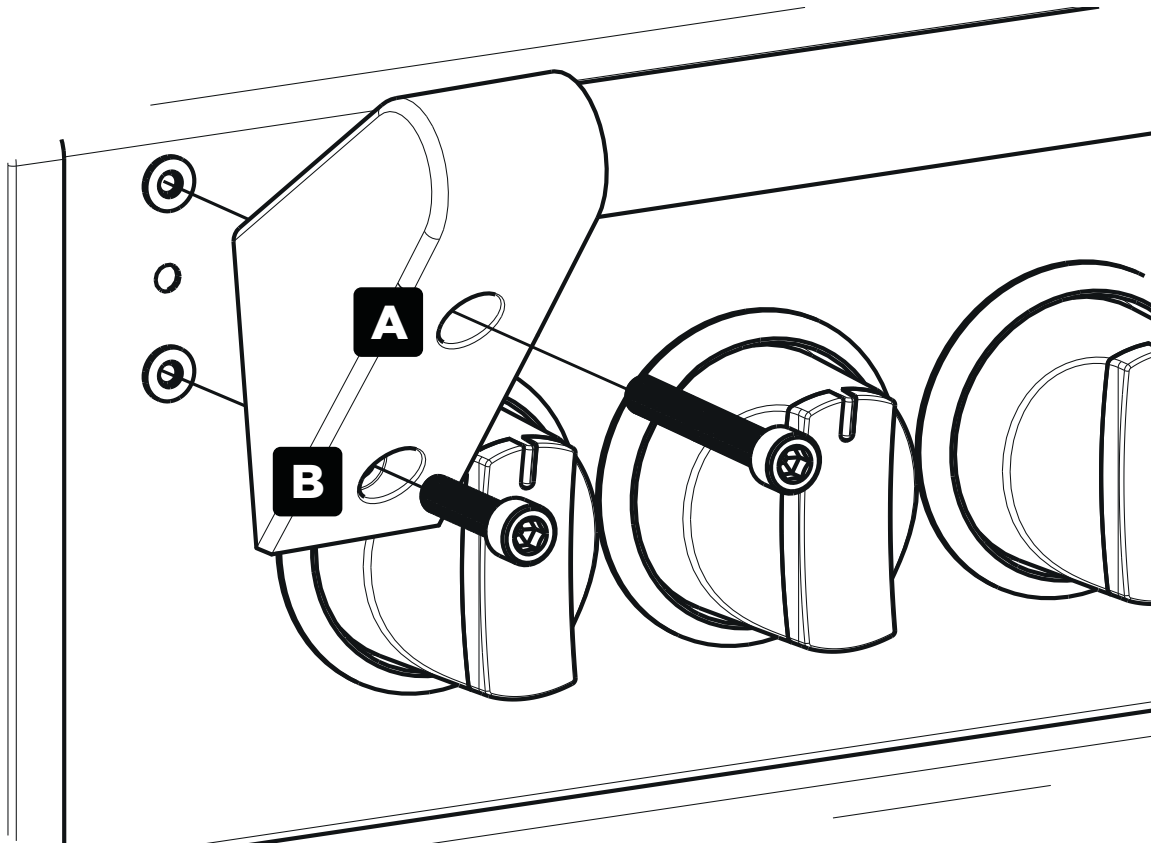

		100 cm	110 cm
Plinth cover	Stainless	015342457	013342458
	Black	013342455	013342456

DIMENSIONS AND CLEARANCES

CUPBOARD / HOOD CLEARANCES

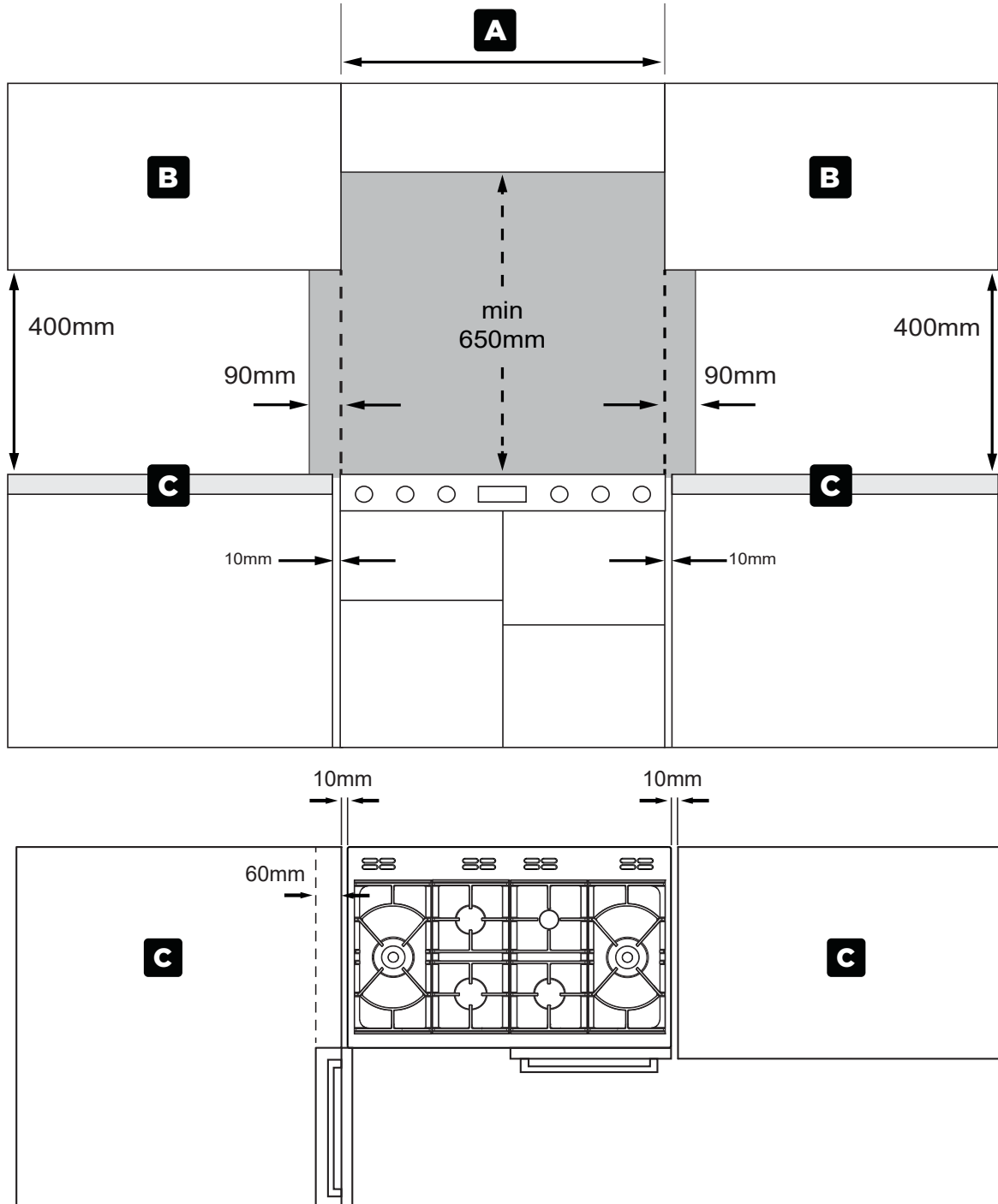

A Nominal width of the hob

B Wall Unit

C Worktop

! No shelf or overhang of combustible material should be closer than 650 mm above the hob.

i If your appliance has a side opening door, we recommend a side clearance of 60 mm to allow the oven door to fully open, if placed up to a wall or cabinetry.

i The cooker must have a side clearance above hob level of 90mm up to a height of 400 mm.

i This cooker may be fitted flush to the base units of your kitchen.

STABILITY BRACKET

If the cooker is fitted with a flexible connection, a stability bracket should be fitted to engage in the back of the cooker. A stability bracket can be bought from your local supplier.

A stability bracket can be fitted as follows:

1. Place the cooker in the position and draw a PENCIL LINE level with the front edge.
2. Mark the centre of the cooker to give the CENTRE LINE for the bracket.
3. Remove the cooker and mark off 450 mm from the PENCIL LINE to locate the front edge of the lower bracket.
4. Fix the bracket to the floor. Measure from floor level to engagement edge in the back of cooker and add 3 mm.
5. Assemble the underside of the top part of the bracket to this height.

Rear wall

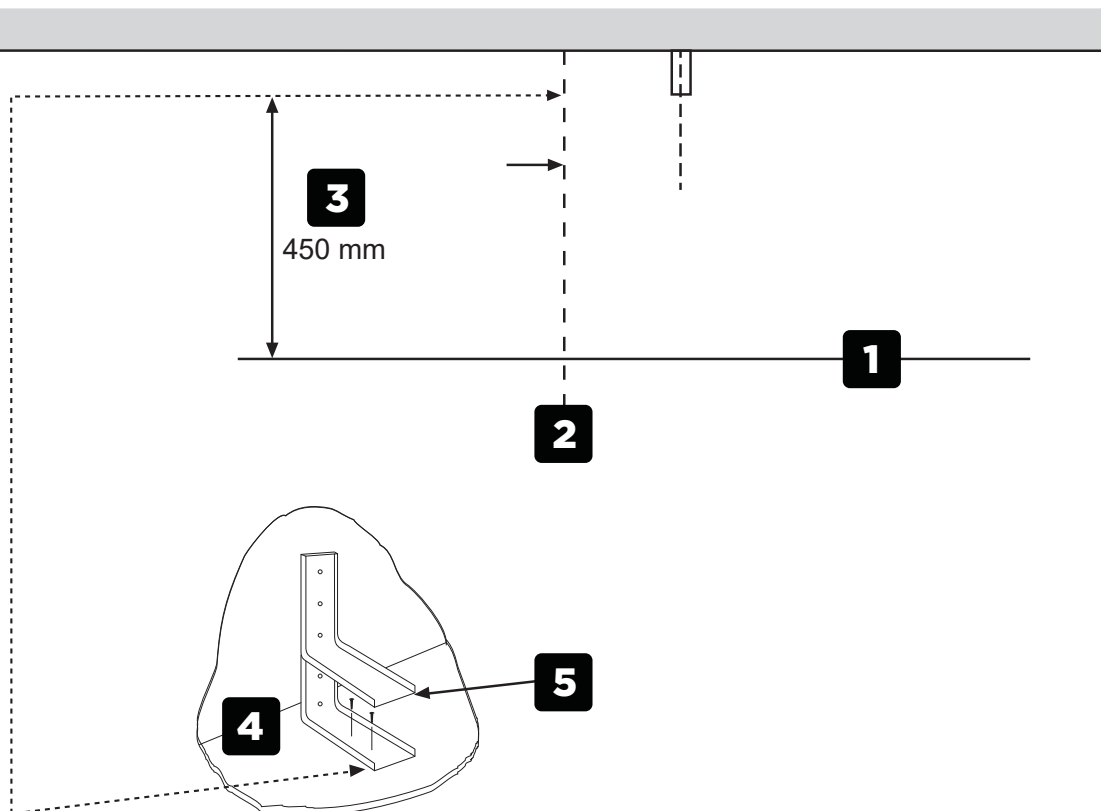

i Underside of top bracket slots into engagement edge in back of cooker.

i Review stability bracket location identified on rear of appliance and position bracket accordingly.

CONNECTION TO THE ELECTRICITY SUPPLY

⚠ WARNING: This appliance must be earthed.

This appliance must be fitted to a switch providing all pole disconnection with a minimum contact separation of 3 mm.

⚠ The terminal block screws and clamps can be damaged by excessive tightening and untightening. **DO NOT USE POWER TOOLS!**

1. Gain access to the mains terminal by removing the terminal block cover at the rear of the appliance.
2. Connection should be made with a suitable flexible cable.
3. First strip the wires then push the cable through the cable clamp.
4. Connect the cable to the terminal block and tighten the cable clamp screws – see diagram.
5. Refit the terminal box cover.
6. Sufficient cable should be used to allow the cooker to be pulled out, but must hang clear of the floor so it does not become twisted or trapped when the cooker is pushed back.

SINGLE PHASE CONNECTION (230 V ~50 HZ)

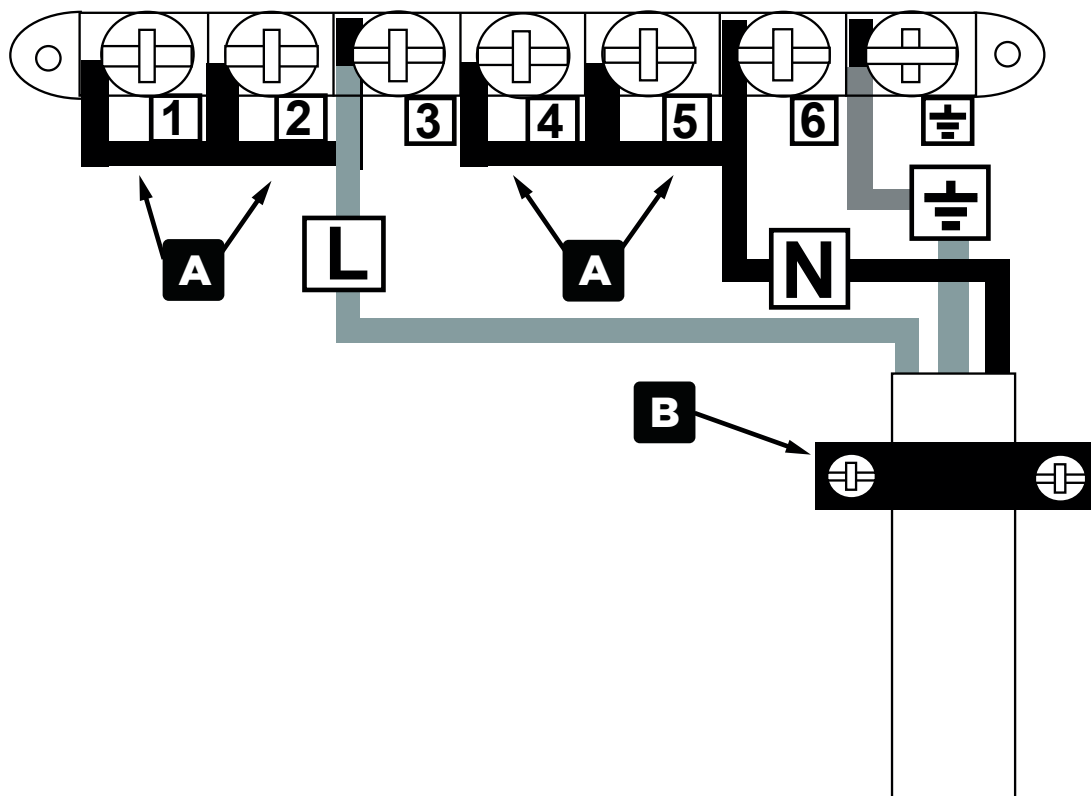

A Shorting Links

B Cable Clamp

7. Connect cable to the terminal block:
 - L to terminal 3
 - N to terminal 6
 - Earth to  terminal

8. Ensure shorting links are fitted between terminals 1-2, 2-3, 4-5 and 5-6.
9. Ensure all screws are fully tightened.

THREE PHASE CONNECTION (230/400 V 3N ~50 HZ)

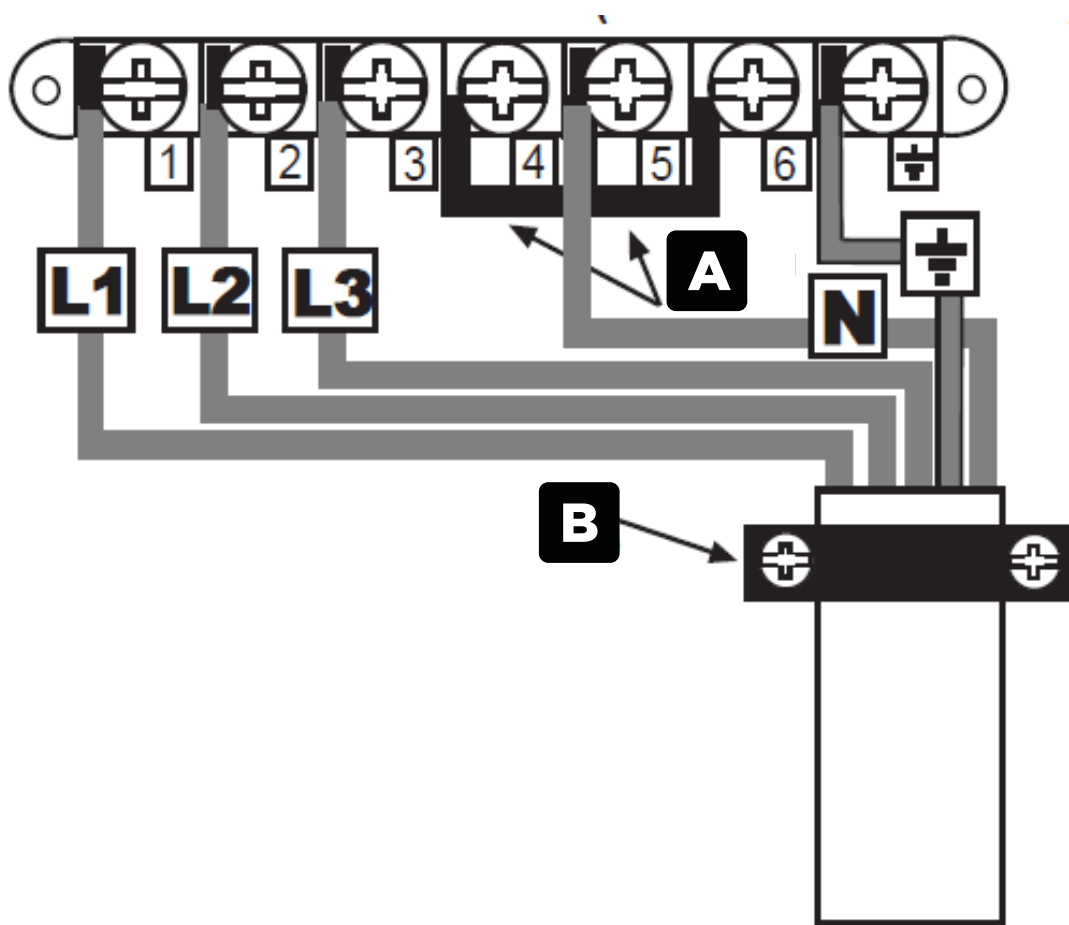

A Shorting Links

B Cable Clamp

7. Connect cable to the terminal block:
 - L1, L2 and L3 to terminals 1, 2 and 3
 - N to terminal 5
 - Earth to  terminal
8. Remove shorting links 1-2 and 2-3.
9. Ensure shorting links are fitted between terminals 4-5 and 5-6.
10. Ensure all screws are fully tightened.

CONNECT TO THE GAS SUPPLY

The inlet to the cooker is ½" BSP internal situated at the rear right corner. Fit the bayonet connection. This should be located so as to ensure that the flexible connector hose does not kink.

 Under no circumstances should the flexible connector be allowed to come into contact with the vertical oven flue tubes on the rear of the appliance.

Use a 900 mm – 1125 mm length of flexible connector.

Ensure that all pipework is of the correct rating for both size and temperature.

Flexible connections should comply with the relevant national regulations and codes of practice in force in the country where it is intended to be installed. Parts of the appliance likely to come into contact with a flexible connector have a temperature rise of less than 70 °C.

After installation, make sure all connections are gas sound.

COMMISSIONING

BURNER AERATION

All burners have fixed aeration and no adjustment is possible.

PRESSURE SETTING

Pressure test point: Use the oven injector.

HOB BURNER

Turn the control knob to the 'FULL ON' position, wait a second before pressing the ignition switch or holding a lighted match or taper to the burner. Hold the control knob in for 15 seconds. Do not hold the control knob in for longer than 15 seconds. If the burner fails to light within this time, release the control knob and wait one minute before attempting further ignition.

CHECK THE OPERATION OF ELECTRICAL COMPONENTS

Clock Programmer/Minute Minder

Check functions as described in the User Guide.

Oven light & Convection fan

Open the main oven door. Turn the main oven control knob to the defrost setting. Check the oven light and convection fan both come on. Turn control knob back to 'OFF' position.

Cooling Fan

Turn the top oven control knob to the full power setting.

Check that the cooling fan operates. Turn control knob back to 'OFF' position and check cooling fan switches off immediately.

i Note: If the cooker does not perform correctly, inform the customer of the problem and put a warning notice on the cooker. If the problem is dangerous, then disconnect the cooker. If there is a fault, then the customer should be advised to contact the manufacturer's local service organisation or the retailer.

i Before leaving the installation hand over the User Guide to the customer

Stoney Lane, Prescot, Merseyside L35 2XW

Product Information Helpline

0344 248 4149