

Whatever the occasion

bellin[®]

think of everything

If you smell gas:

Do not try to light any appliance. Do not touch any electrical switch.

Call the Gas Emergency Helpline at TRANSCO on: **0800 111999**

The appliance must be installed (and serviced) by a Corgi registered approved installer or a person competent to ensure that the installation is in accordance with "The Gas Safety (Installation and Use) Regulations 1994", and the "The Gas Safety (Installation and Use) (Amendment) Regulations 1996". Failure to comply with these Regulations is a criminal offence.



Contents

User's Section	2 - 25
Introduction	2
Be Safe - Not Sorry.	5
Using the Hob	6
Using the Grill	8
Using the Ovens.	10
Ignition	10
Oven furniture	12
Slow cooking	12
Top oven baking guide	13
Main oven baking guide	14
Traditional fruit cakes	15
Roast turkey	15
Roasting guide	16
Automatic cooking	17
Programmer / Clock (if fitted).	19
Minute minder (if fitted)	23
Cleaning	24
Installation Instructions	26 - 30
Technical Data	31
Belling Customer Care.	32

Please keep this handbook for future reference, or for anyone else who may use the appliance.

Introduction

Thank you for choosing a British built appliance by Belling

We hope that the following information will help you to familiarise yourself with the features of the appliance, and to use it successfully and safely.

Our policy is one of constant development & improvement. Strict accuracy of illustrations and specifications is not guaranteed. Modification to design and materials may be necessary subsequent to publication.

This appliance must be installed in accordance with the regulations in force, and only in a well ventilated space. Read the instructions before installing or using this appliance.

Your new appliance is designed to be installed flush to base units.

Your 1st Year Guarantee

To fulfil the conditions of your guarantee, this appliance must be correctly installed and operated, in accordance with these instructions, and only be used for normal domestic purposes.

Please note that the guarantee, and Service availability, only apply to the UK and Republic of Ireland.

Stability bracket

If the cooker is to be fitted with a flexible inlet connection, a stability bracket should also be fitted to engage in the back of the cooker. Make sure this is re-engaged whenever you move the cooker for cleaning.

Gas & Electrical connection

Please refer to installation instructions for the Gas & Electrical Safety Regulations and the Ventilation Requirements.

In your own interest, and that of safety, it is the law that all gas appliances be installed by competent persons who will ensure that the installation is in accordance with "The Gas Safety (Installation & Use) Regulations", and the "The Gas Safety (Installation and Use) (Amendment) Regulations". Failure to comply with these Regulations is a criminal offence.

Corgi registered installers undertake to work to satisfactory standards.

Disconnection of gas and electric appliances should always be carried out by competent persons.

Warning: This appliance must be earthed.

Before using the appliance for the first time, remove any protective polythene film and wash the oven shelves and furniture in hot soapy water, to remove their protective coating of oil. Even so, when you first turn on the oven or grill you may notice a smell and some smoke.

Introduction

Glass door panels

To meet the relevant Standards of Domestic cooking appliances, all the glass panels on this appliance are toughened to meet the fragmentation requirements of BS3193. This ensures that, in the unlikely event that a panel breaks, it does so into small fragments to minimise the risk of injury.

Please take care when handling, using or cleaning all glass panels as any damage to the surfaces or edges may result in the glass breaking without warning or apparent cause at a later date. Should any glass panel be damaged, we strongly recommend that it is replaced immediately.

The cooling fan

When the appliance is switched on, you may hear the cooling fan come on. This keeps the fascia and control knobs cool during grilling / cooking and will continue to operate for up to 15 minutes after the appliance has been switched off.

During oven use the fan may cycle on and off. Should any fault occur with the cooling fan, the appliance will require servicing. Contact Customer Support.

Ventilation

The use of a gas cooking appliance results in the production of heat and moisture in the room in which it is installed. Ensure that the kitchen is well ventilated: keep natural ventilation

holes open or install a mechanical ventilation device (mechanical extractor hood). Prolonged intensive use of the appliance may call for additional ventilation, for example, opening of a window, or more effective ventilation, for example increasing the level of mechanical ventilation where present.

If the ignition fails:

- Check there is a spark when the ignition button is depressed. If there is no spark, check that the electricity supply is switched on at the socket.
- Check that the gas supply is switched on.
- Try another appliance in the socket, if that works, replace the 3 amp fuse in the cooker plug.

Moving the cooker

Do not attempt to move the cooker by pulling on the doors or handles. Open the door and grasp the frame of the cooker, taking care that the door does not shut on your fingers.

Take care to avoid damage to soft or uneven floor coverings when moving the appliance. Some cushioned vinyl floor coverings may not be designed to withstand sliding appliances without marking or damage.

Introduction

Environmental Protection

We are committed to protecting the environment and operate an Environmental Management System which complies with BS EN ISO 14001.

Disposal of packaging

- All our packaging materials are recyclable and environmentally friendly.
- Please help us to protect our environment by disposing of all packaging in an environmentally friendly manner.
- Please contact your local authority for the nearest recycling centre.

Caution: Packaging materials can pose a risk of suffocation - keep away from children.

To replace a light bulb

Caution: Switch off the electricity supply to the cooker at the socket, to avoid the risk of electric shock. Wait until the oven is cool, then remove the oven shelves.

Grasp the lens cover on the light fitting and pull it away from the side of the oven. Unscrew the bulb.

Please note that the oven light bulb is not covered by the guarantee. Replacement bulbs can be ordered from your local supplier, or bought from a hardware store.

Be Safe - Not Sorry

When you are cooking, keep children away from the vicinity of the appliance.

This product is designed as a domestic cooking appliance for the preparation and cooking of domestic food products, and should not be used for any other purpose.

- Remove all packaging, protective films and oils from the appliance before using for the first time.
- Make sure you read and understand the instructions before using the appliance.
- Keep electrical leads short so they do not drape over the appliance or the edge of the worktop.
- Keep all flammable materials (such as curtains, furnishings & clothing) away from the appliance.
- Parts of the appliance may be hot during or immediately after use. Allow sufficient time for the appliance to cool after switching off.
- Never use the appliance for heating a room.
- Do not drape tea towels over the flue vents or door, as this creates a fire hazard.
- When opening the appliance door, take care to avoid skin contact with any steam which may escape from the cooking.

- Do not use aluminium foil to cover the grill pan, or put items wrapped in foil under the grill as this creates a fire hazard.
- Do not use the oven with the door inner glass panel removed.
- Use oven gloves when removing hot food / dishes from the oven or grill. The oven / grill and utensils will be very hot when in use.
- Do not use foil on oven shelves or allow it to block the oven flue, as this creates a fire hazard, and prevents heat circulation.
- Switch off the electricity supply before replacing the oven light bulb (if fitted), to avoid the risk of electric shock.
- When cooking heavy items - eg; turkeys - do not pull the oven shelf out with the item still on the shelf.
Drop-down top oven door: Do not place items on the door when open.
- When you have finished cooking check that all controls are in the "off" position.

All installation, servicing and maintenance work should be carried out by a competent person who will comply with current Regulations, Standards and Requirements.

As with all gas appliances, it is recommended that your appliance is serviced regularly.

Using the Hob

Burner Ignition

Push in and turn the selected control knob anticlockwise to the 'full on' position and press the ignition switch, or hold a lighted match or taper to the burner, until the burner lights. Turn the control knob to the required setting.

Adjust the burner flame so that it does not extend over the pan base.

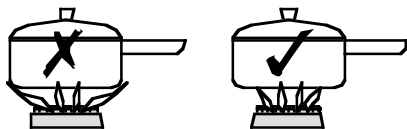

To turn off, push in the control knob and turn clockwise until the dot on the control knob is below the dot on the fascia panel.

Wok Burner Ignition

Please note: Certain models have a wok burner. The wok burner is distinguished by its two burner caps.

Push in and turn the wok burner control knob to the 'simmer' position (*small flame symbol*) and press the ignition switch or hold a lighted match or taper to the burner, until it lights. Turn the control knob to the required setting.

Important note: Please keep the time between turning the control knob to the on position, and lighting the burner as short as possible for best results.

To simmer - all burners

The simmer position is marked by the *small flame symbol*.

Turn the selected control knob past the *large flame symbol* (FULL ON) to the *small flame symbol*.

You may hear a slight popping noise when the hob burners are operating and this is quite normal, but if anything about the cooker appears unusual, such as change in flame appearance, or the operation of controls - seek expert advice.

The control knob can be set at any position between the *small flame* and *large flame* symbols, allowing for greater control, and flexibility, while cooking.

Using the Hob

Pans

For optimum safety and performance, we recommend the use of flat bottomed pans with a base diameter of minimum 100mm (4") and maximum 250mm (10").

Do not use double pans, rim based pans, old misshapen pans or any pan which is unstable when placed on a flat surface.

Position pans over the centre of the burners, resting on the pan supports. If positioned off centre, smaller pans may be unstable.

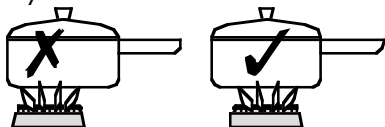

When cooking with fat or oil, never leave unattended.

Turn pan handles to a safe position, so they are out of reach of children, not overhanging the appliance, and cannot be caught accidentally.

Commercial simmering aids should not be used as they create excessive temperatures that can damage the surface and may cause a hazard.

Pan supports

Always make sure the pan supports are replaced correctly, and located in the hob spillage well.

To save gas

- Use the size of pan most suited to the size of the burner - ie; larger pans on the larger burners, smaller pans on the smaller burners.
- Adjust the flames so that they do not lick up the sides of the pan.
- Put lids on saucepans and only heat the amount of liquid you need.
- When liquids boil, reduce the control setting to maintain a simmer.
- Consider the use of a pressure cooker for the cooking of a complete meal.
- Potatoes and vegetables will cook quicker if chopped into smaller pieces.

The fold down lid

Caution: Glass lids may shatter when heated. Turn off all the burners before shutting the lid.

When opening and closing the lid, use the cooler outer sides of the lid glass.

The lid must be opened fully, so there is no danger of it closing while the hob is being used.

The appliance is fitted with a switch-back system, which will automatically turn off the hotplate controls if they are inadvertently left on as the lid is closed.

The lid is not intended to be used as a work surface, as it becomes hot when any part of the cooker is in use, and the surface may be scratched if items with rough or sharp surfaces are placed on it.

Using the Grill

Caution: Accessible parts may be hot when the grill is used - young children should be kept away.

Ignition

Open the top oven / grill door.

Push in and turn the top oven / grill control knob clockwise to the 'FULL ON' position. Hold the control knob in, and press the ignition switch or hold a lighted match or taper to the burner, until the burner lights.

If after 15 seconds, the burner has not lit, switch off the grill and leave the compartment door open. Wait at least one minute before a further attempt to ignite the burner.

Do not hold the control knob in for more than 15 seconds.

In the event of the grill burner flames being accidentally extinguished, turn off the burner control and do not attempt to re-ignite the burner for at least one minute.

When slower cooking is required the grill can be turned down anti-clockwise to a slightly reduced setting, past the full grill symbol (full on), to the half grill symbol. This can be used in conjunction with use of the different grilling positions (see below).

To switch off, push in the control knob and turn anticlockwise to return it to the off position.

Important: The top oven / grill door must be fully open when the grill is used.

Preheating

For best cooked results, we recommend that you preheat the grill for about 3 minutes.

Using the Grill

Detachable grill pan handle

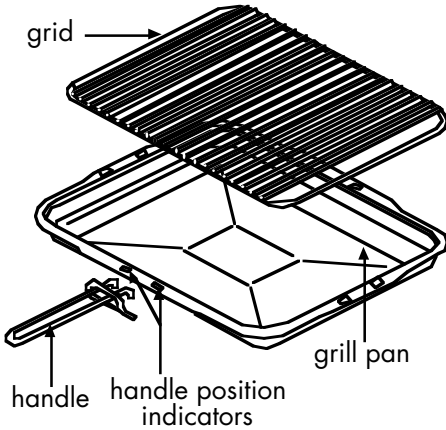

Place the handle over the edge of the grill pan, at the narrow side edges. Slide the handle to the centre, and locate between the handle position

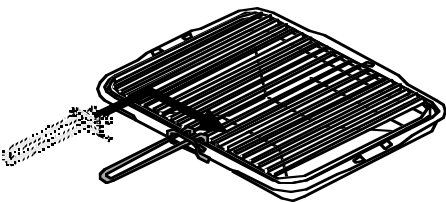

The handle should be removed from the pan during grilling, to prevent overheating. The handle is designed for removing / inserting the grill pan under the grill when grilling.

If cleaning the grill pan when it is hot, use oven gloves to move it. Do not use the handle to pour hot fats from the grill pan.

Food for grilling should be positioned centrally on the trivet.

Using the grill

Push the grill pan towards the back of the shelf, to position it under the grill.

The speed of grilling can be controlled by selecting a higher or lower shelf position.

For toasting, and for grilling foods such as bacon, sausages or steaks, use a higher shelf position.

For thicker foods such as chops or chicken joint pieces, use a middle to low shelf position.

The grill trivet, inside the grill pan, can be inverted to give a high or low position, or it may be removed.

The HIGH trivet position is suitable for toasting bread.

The LOW trivet position is suitable for grilling all types of meat & fish.

With the grill trivet removed the food is placed directly on the base of the grill pan - eg; when cooking whole fish or browning dishes such as cauliflower cheese.

When you have finished grilling, check that the control knob is returned to the off position.

Using aluminium foil

Using aluminium foil to cover the grill pan, or putting items wrapped in foil under the grill creates a fire hazard.

Using the Ovens

Caution: When you are cooking keep children away from the vicinity of the oven.

If it is found, over a period of time, that the ovens become hotter when used at a particular temperature, then the thermostat may need to be replaced.

In the event of the oven burner flame being accidentally extinguished, turn off the burner control and do not attempt to re-ignite the oven burner for at least one minute.

Models with Minute Minders **Using the main oven**

Ignition

Push in and turn the main oven control knob to the 'FULL ON' position (gas mark 9). Hold the control knob in, and press the ignition switch or hold a lighted match or taper to the burner, until the burner lights.

If after 15 seconds, the burner has not lit, turn off the oven and leave the compartment door open. Wait at least one minute before a further attempt to ignite the burner.

Do not hold the control knob in for more than 15 seconds.

Turn the control knob to the required setting.

To turn off, return the control knob to the "off" position.

Models with Automatic Programmers **Using the main oven**

Ignition

Turn the oven control knob to gas mark 9. Making sure that the door is closed. The automatic ignition will begin to spark.

It can take up to 60 seconds for the oven burner to come on to full rate, with the door closed.

Adjust to the required setting.

To turn off, return the control to the "●" off position

Turn the control knob to the required setting.

To turn off, push in the control knob and turn clockwise to return it to the "off" position.

Using the Ovens

Using the top oven

Ignition

Push in and turn the top oven control knob anticlockwise to the 'FULL ON' position (gas mark 9). Hold the control knob in, and press the ignition switch or hold a lighted match or taper to the burner, until the burner lights.

If after 15 seconds, the burner has not lit, switch off the oven and leave the compartment door open. Wait at least one minute before a further attempt to ignite the burner.

Do not hold the control knob in for more than 15 seconds.

Turn the control knob to the required setting.

To switch off, return the control knob to the off position.

Using the top oven

The top oven can be used in the same way as the main oven, to cook the full range of dishes, but it is a SECONDARY oven and there are some differences.

Foods cooked in the top oven should be in relation to the oven size. Larger dishes, or food which may rise during cooking, should be cooked in the main oven.

Large items, wide tins and tall items such as rich fruit cakes should be cooked in the main oven to obtain optimum results.

Notes:

As part of the cooking process, hot air is expelled through a vent at the top of the oven(s). When opening the oven door, care should be taken to avoid any possible contact with potentially hot air, since this may cause discomfort to people with sensitive skin. We recommend that you hold the underneath of the oven door handle.

Preheating

Always preheat the top oven for 15 minutes. However, if the main oven is being used at the same time, then preheating may not be necessary. The cooking time may need to be shortened slightly, or the cooking temperature adjusted, to allow for heat transfer from the main oven to the top oven if both ovens are used together.

Preheat the main oven for 15 minutes.

If you are not preheating the ovens, the cooking times in the baking guides may need to be extended, as they are based on a preheated oven.

The ovens **must** be preheated when reheating frozen or chilled foods, and we recommend preheating for yeast mixtures, batters, soufflés and whisked sponges.

Put the oven shelves in the position required before preheating the oven.

Oven light

Press the light button on the fascia panel.

Using the Ovens

Zones of heat

The temperature at the **centre** of the oven corresponds with the selected gas mark and is slightly higher towards the top of the oven and slightly lower towards the oven base.

These zones of heat can be useful as different dishes requiring different temperatures can be cooked at the same time, when more than one shelf is used.

The temperature at the oven base is suitable for cooking baked vegetables, baked fruit, milk pudding etc, and for warming bread rolls, soup, coffee, or ovenproof plates and dishes.

If you find that over a period of time, the oven becomes hotter when used at a particular gas mark, the thermostat may need to be replaced. **Oven furniture**

Baking tray and roasting tins

For best cooked results and even browning, the maximum size baking trays and roasting tins that should be used are as follows;

Baking tray 350mm x 330mm

Roasting tin 370mm x 320mm

Position baking trays and roasting tins on the middle of the shelves, and leave one clear shelf position between shelves, to allow for circulation of heat.

Oven shelves

Extra shelves may be ordered from your local supplier.

The oven shelf must be positioned with the upstand at the rear of the oven and facing upwards.

You will see that there are differences between the oven shelves for the top oven and the main oven.

The top oven shelf helps to ensure even baking in the top oven. It has a rear deflector fitted to it, and is **not** intended for use in the main oven.

Slow cooking

Make sure that frozen foods are thoroughly THAWED before cooking.

Do not slow cook joints of meat or poultry weighing more than 2½kg / 4½lb.

Always use the top half of the oven for slow cooking.

For roasting joints of meat or poultry, and for pot roasts preheat the oven to gas mark 6 and cook for 30 minutes, then adjust the oven control to the "S" slow setting for the remainder of the cooking time.

Slow cooking times will be about three times as long as conventional cooking times.

Using the Ovens

Top oven baking guide

Dish	Recommended gas mark	Suggested shelf position	Approximate cooking time (preheated oven)
Scones Meringues	7 "S" slow setting	top - middle bottom	10 - 15 mins 2 - 3 hours
Cakes Small cakes Whisked sponge Swiss roll Victoria sandwich (2 x 180mm / 7" per shelf) Genoese sponge (2 x 180mm / 7" per shelf)	5 5 6 4 5	middle middle middle middle (side by side) middle	15 - 25 mins 20 - 30 mins 10 - 12 mins 20 - 35 mins 25 - 30 mins
Pastry Rough Puff Flaky / Puff Shortcrust Flan	7 6 6 6	middle middle middle middle	cooking time depends on recipe & type of filling
Biscuits Shortbread fingers Nut brownies Brandy snaps Flapjacks Ginger nuts	5 5 4 4 5	middle - top middle middle - top middle - top middle - top	20 - 30 mins 25 - 35 mins 10 - 15 mins 25 - 40 mins 15 - 20 mins

Baking guide hints

The gas mark settings and times given in the top baking guides are based on dishes made with block margarine. If tub margarine is used, it may be necessary to reduce the gas mark setting.

If a different gas mark setting to that shown in our guide is given in a recipe, the recipe instruction should be followed.

The cooking times given in the baking guides are based on a preheated oven. If you do not preheat the oven, cooking times should be extended.

Using the Ovens

Main oven baking guide

Dish	Recommended gas mark	Suggested shelf position	Approximate cooking time (preheated oven)
Scones Meringues	7 "S" slow set	middle - top bottom	8 - 15 mins 2 - 3 hours
Cakes Small cakes Whisked sponge Swiss roll Victoria sandwich (2 x 180mm / 7") Genoise sponge Madeira (180mm / 7") Gingerbread Semi rich fruit cake (205mm / 8") Christmas cake (205mm / 8") Dundee cake (205mm / 8")	5 5 6 4 4 3 3 2 or 3 1 or 2 3	middle - top middle - top middle - top middle - top middle middle middle middle - bottom bottom middle - bottom	15 - 25 mins 20 - 25 mins 10 - 12 mins 20 - 30 mins 20 - 30 mins 1 - 1½ hours 1 - 1½ hours 2½ - 3 hours depending on recipe 2- 2½ hour
Pastry Rough Puff Flaky / Puff Shortcrust Flan	7 6 6 6	middle - top middle - top middle - top middle - top	cooking time depends on recipe & type of filling
Biscuits Nut brownies Brandy snaps Flapjacks Ginger nuts	5 4 4 4	middle - top middle - top middle - top middle - top	25 - 35 mins 10 - 12 mins 20 - 25 mins 10 - 20 mins

Using the Ovens

Traditional fruit cakes

It should be remembered that ovens can vary over time, therefore cooking times can vary, making it difficult to be precise when baking fruit cakes.

It is necessary therefore, to test the cake before removal from the oven. Use a fine warmed skewer inserted into the centre of the cake. If the skewer comes out clean, then the cake is cooked.

- Do not attempt to make Christmas cakes larger than the oven can cope with, you should allow at least 25mm (1 inch) space between the oven walls and the tin.
- Always follow the temperatures recommended in the recipe.
- To protect a very rich fruit cake during cooking, tie 2 layers of brown paper around the tin.
- We recommend that the cake tin is not stood on layers of brown paper, as this can hinder effective circulation of air.
- Do not use soft tub margarine for rich fruit cakes, unless specified in the recipe.
- Always use the correct size and shape of tin for the recipe quantities.

Roast turkey

Roasting turkey involves cooking two different types of meat - the delicate light breast meat, which must not be allowed to dry out, and the darker leg meat, which takes longer to cook.

The turkey must be roasted long enough for the legs to cook, so frequent basting is necessary. The breast meat can be covered once browned.

- Always make sure that the turkey is completely thawed and that the giblets are removed before cooking.
- Turkey should be roasted at gas mark 5 for 20 minutes per lb, plus 20 minutes, unless packaging advises otherwise.
- The turkey can be open roasted, breast side down, for half of the cook time, and then turned over for the remainder of the cooking time.
- If the turkey is stuffed, add 5 minutes per lb to the cooking time.
- If roasting turkey covered with foil, add 5 minutes per 1lb to the cooking time.

To test if the turkey is cooked, push a fine skewer into the thickest part of the thigh. If the juices run clear, the turkey is cooked. If the juices are still pink, the turkey will need longer cooking.

Using the Ovens

Roasting guide

The times given in the roasting guide are only approximate, because the size and age of the bird will influence cooking times as will the shape of a joint and the proportion of the bone.

Frozen meat should be thoroughly thawed before cooking. For large joints it is advisable to thaw overnight.

Frozen poultry should be thoroughly thawed before cooking. The time required depends on the size of the bird - eg; a large turkey may take up to 48 hours to thaw.

Use of a trivet with a roasting tin will reduce fat splashing and will help to keep the oven interior clean. Alternatively, to help reduce fat splashing, potatoes or other vegetables can be roasted around the meat / poultry.

Notes:

- When cooking stuffed meat or poultry calculate the cooking time from the total weight of the meat plus the stuffing.
- For joints cooked in foil or covered roasters, and for lidded casseroles, add 5 minutes per 450g (1lb) to the calculated cooking time.
- Smaller joints weighing less than 1.25kg (2½lb) may require 5 minutes per 450g (1lb) extra cooking time.
- Position the oven shelf so that the meat or poultry is in the centre of the oven.
- It is recommended that the appliance is cleaned after open roasting.

Cook in oven at Gas Mark 5		Approximate Cooking Time (preheated oven)
Beef	Rare Medium Well done	20 minutes per 450g (1lb), plus 20 minutes 25 minutes per 450g (1lb), plus 25 minutes 30 minutes per 450g (1lb), plus 30 minutes
Lamb	Medium Well done	25 minutes per 450g (1lb), plus 25 minutes 30 minutes per 450g (1lb), plus 30 minutes
Pork		35 minutes per 450g (1lb), plus 35 minutes
Poultry		20 minutes per 450g (1lb), plus 20 minutes

Using the Oven

Automatic cooking in the main oven

The automatic cooking facility is controlled by the programmer (see 'Programmer/ Clock' section) and allows complete meals, or individual dishes to be cooked while you are out of the house, to be ready for when you return.

The '*Ready Time*' should be set as close as possible to, or just after your anticipated return so food is not left standing in a warm oven.

Do

- Select foods which are as fresh as possible, and as cold as possible - ie; preferably straight from the refrigerator.
- Choose foods which are suitable for cooking from a cold start, as some dishes will be affected by being left uncooked, at room temperature, perhaps for several hours - eg; a wet filling on a pastry base.
- Make sure that meat and poultry are thoroughly thawed (but still cold from the refrigerator), before placing them in the oven, and avoid using rolled joints of meat which can be more susceptible to the growth of food poisoning organisms.
- Cover dishes with lids or foil to keep the food moist, prevent the transfer of odours, and protect from possible contamination; the food can be uncovered towards the end of cooking to crisp and brown.

Do not

- Warm food should never be placed in the oven if there is a delay period. Stews prepared by frying the meat and vegetables first should be cooked as soon as possible, or refrigerated prior to placing in the oven.
- Some dishes are not suitable for cooking on automatic - eg; dishes containing left over cooked meat or poultry, eggs, cooked rice or seafood.
- Do not put food items (intended for automatic cooking) into a warm oven. Allow the oven to cool before setting for automatic cooking.
- Do not over-fill dishes containing liquids as they might boil over.
- Never leave food in the oven to cool slowly after cooking; serve immediately or refrigerated.
- Never use the automatic facility to reheat 'cook chill' foods as they should go straight from the refrigerator into a preheated oven.

Using the Oven

Important: Food is more susceptible to the growth of food poisoning organisms in warm conditions. If the weather is hot, either take care to ensure that food is not left standing in a warm oven, or avoid using the automatic cooking facility.

Hints for automatic cooking

- Food is placed in a cold oven so you will need to add about 10 - 15 minutes onto the cooking time to allow for the oven to reach the selected temperature.
- Wine or beer may ferment, and cream may curdle during the delay period, so it is best to add these ingredients just before serving.
- Potatoes should be parboiled or brushed with oil to prevent discolouration during the delay period.
- Meat can be brushed with oil to prevent it drying.
- Lemon juice can be added to certain fruits and vegetables such as apples, pears, turnips and parsnips to prevent discolouration during the delay period.

Programmer / Clock (if fitted)

Automatic cooking is only available in the main oven.

The programmer buttons

▽ minus

△ plus

The 'function' button in the centre is used for setting the minute minder and setting up the automatic cooking. See below for details.

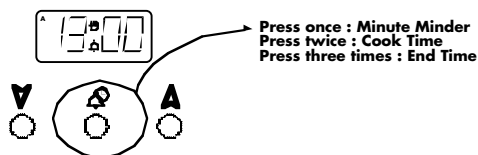

Symbols on the LED display.

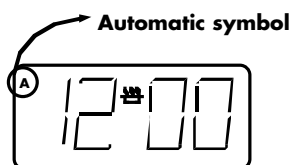

This 'A' symbol appears when either a semi, or fully automatic program is selected. This symbol will flash while a program is being set. Once a program is set the symbol will light up, and remain lit until the alarm sounds, or the program is cancelled

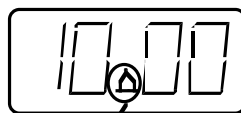

Minute Minder symbol

This Bell symbol appears when the Minute Minder function has been selected. While the Minute Minder is being set, the Bell symbol flashes. Once the length of time is set, the Bell symbol remains lit until the time runs down, or the function is cancelled.

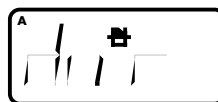

This message and 'A' symbol appear when you are asked to set the length of time you require the oven to cook automatically for. Using the Plus and Minus buttons adjusts this accordingly.

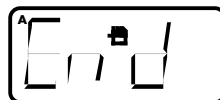

This message and 'A' symbol appear when you are asked to enter in an end time, or when you would like the oven to switch itself off.

Programmer / Clock (if fitted)

To set the time of day

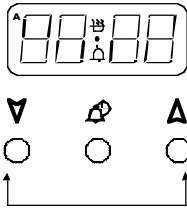

- ◆ Press the Plus and Minus buttons together for a few seconds, and release.
- ◆ The '●' in between the numbers on the LED Display will begin to flash.
- ◆ While the '●' is flashing it is possible to adjust the time using the Plus and Minus buttons. Once the time has been set, allow approximately 30 seconds before using any of the other timer functions. This ensures that the time will remain correct.

To select an alarm tone

There are three tones to chose from.

- ◆ Press the *minus* button to listen to the first tone.
- ◆ Release the *minus* button and press it again to listen to the second tone etc.
- ◆ Releasing the *minus* button after the tone has sounded will automatically select that tone

Setting the minute minder

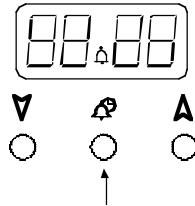

- ◆ To set the Minute Minder, press the Function button once. The bell symbol will appear and start flashing. The flashing only lasts for 5 seconds so the time must be set within this time frame.
- ◆ Use the Plus and Minus button to set the length of time required. Once this has been done, the Minute Minder is set.
- ◆ When the desired length of time has counted down the alarm will sound.
- ◆ To cancel the tone, press any of the buttons.
- ◆ To cancel the Minute Minder at any time, press the function button, then press the Plus and Minus buttons together.

Programmer / Clock (if fitted)

Semi-automatic cooking

There are two types of semi automatic cooking available on this appliance.

The oven must be switched on, and in use to use either of these functions successfully.

The Duration method allows you to set the oven for a specific length of time. If a dish needed 2 hours to cook, then it would be possible for you to set the oven to turn off 2 hours later. This allows you to be sure that your food will be cooked for a set length of time and no longer.

The End Time method allows you to enter a specific time when you would like the oven to switch off. If you wish to leave the oven unattended, then it offers peace of mind that the oven will have turned itself off at the set time.

To cancel the semi automatic programs, press both the Plus and Minus buttons together. This can be done at any time during the cooking process. Then if necessary, re program.

For the instructions on how to use both of these functions, please see the following page.

Fully automatic cooking

This function incorporates both a duration and an end time and is meant to be used when you wish to delay the start time.

We recommend that the first few times this function is used you are in the house, this will familiarise you with your oven and prevents food from being over cooked or under cooked.

Care must be taken when selecting foods for this function, it is not recommended for certain food items which may spoil, or are sensitive to being left.

It is also advisable to set the end time to be as close to your return as possible to prevent food being left standing.

To check the Duration time set press the function button twice. To check the End Time press the function button three times.

To cancel the automatic programmer press the Plus and Minus buttons together and then make sure the oven is switched off.

Programmer / Clock (if fitted)

Semi-automatic cooking

The Duration method

◆ Press the Function button twice, **(1)** which will skip past the Minute Minder.

◆ The LED display will flash the word 'dur', **(2)** and the 'A' will flash on the left hand side of the display.

◆ Use the Plus and Minus buttons to set the length of time you want to cook for. **(3)** This must be done within 5 seconds or the time of day will show again.

Once this is done the oven will automatically switch off once the time has elapsed, and the alarm will sound.

To switch off the alarm, press any button. To view any remaining time press the function button twice

The End Time method

◆ Press the Function button three times, which will skip past the Minute Minder and the Duration programmer. **(4)**

◆ The LED display will flash the word 'End' and the 'A' will flash on the left hand side of the display. **(5)**

◆ Use the Plus and Minus buttons to select the time the oven is required to turn off. **(6)**

Once this is done the oven will turn itself off at the time you have selected. To switch off the alarm, press any button.

1. The Duration method

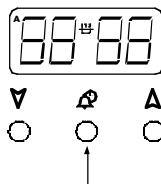

2.

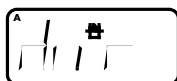

3.

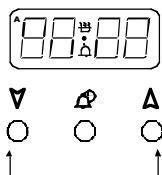

4. The End Time method

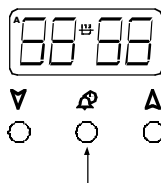

5.



6.

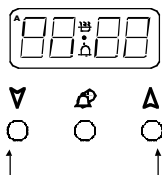

Programmer / Clock (if fitted)

Fully automatic cooking (example)

This programming method is best suited for when a delayed start time is required. Unlike the semi automatic methods this requires both the duration and the end time to be entered. The timer will work out the start time and begin cooking.

◆ Press the function button twice to select the length of time your food will need. **(7)**

◆ The 'A' on the left hand side will flash and the 'dur' message will flash up. **(8)**

◆ Using the Plus and Minus buttons set the time you require within 5 seconds of the 'dur' message. **(9)**

◆ Press the function button three times until the 'A' flashes again and the 'End' messages appears. **(10) & (11)**

◆ Using the Plus and Minus buttons, set the time you would like the oven to switch off. **(12)**

◆ Set the temperature of the oven and place the food inside. While the automatic function is running, the 'A' will appear statically on the display, with the time.

Try to keep the end time as close to when you expect to return, this will prevent cooked food from being left standing in a warm oven.

The timer will calculate the appropriate start time.

7

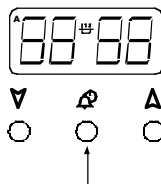

8

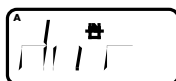

9

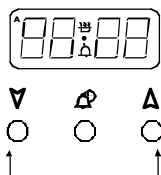

10

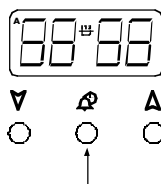

11

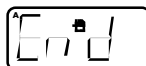

12

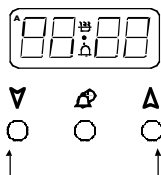

Minute Minder (if fitted)

Initial display

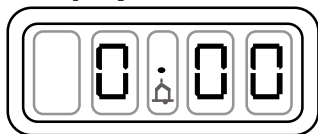

Minus
button



Function
select



Plus
button

The digital timer enables you to set the time of day (24 hour clock) and the minute minder alarm.

Setting the time of day

1. Switch on the electricity supply to the appliance.
2. Press and release the function button.
3. Set the time of day, using the *plus* and *minus* buttons.
4. The time will be set 7 seconds after the last *plus* or *minus* operation.

Changing the time of day

1. Press the function button once.
2. Set the time of day, using the *plus* and *minus* buttons.
3. The time will be set 7 seconds after the last *plus* or *minus* operation.

Alarm tones

After setting the time of day, you can select one of three alarm tones.

Press the *minus* button to listen to the first tone, then release the *minus* button

and press again to listen to the second tone, etc.

Releasing the *minus* button after a tone has sounded will automatically select that tone.

Setting the minute minder

1. Press and release the *plus* button, to change the display from clock to minute minder - the bell symbol will light.
2. Use the *plus* and *minus* buttons to set the length of time before the alarm tone will sound. The display will increase / decrease in units of 10 seconds up to 99 minutes, 50 seconds, and in units of 1 minute from 1 hour 40 minutes upwards. The maximum period which may be set is 10 hours.

The display format will change after 99 minutes and 50 seconds to 1 hour and 40 minutes.

During countdown, the minute minder has priority on the display, which will show (in *minutes : seconds*, or *hours : minutes*) the time remaining.

When countdown is complete, the tone will sound for 7 minutes, or it can be reset with one touch of any button.

To cancel the minute minder at any time.

Run down the set time with the *minus* button. The display will show the time of day

Cleaning

Caution: Any cleaning agent used incorrectly may damage the appliance.

Always let the cooker cool before cleaning.

Some cooking operations generate considerable amount of grease, this combined with spillage can become a hazard if allowed to accumulate on the cooker through lack of cleaning. In extreme cases this may amount to misuse of the appliance and could invalidate your guarantee.

It is recommended that the appliance is cleaned after open roasting.

Do not use caustic, corrosive or abrasive cleaning products, products containing bleach, coarse wire wool or any hard implements, as they will damage the surfaces.

All parts of the appliance can be safely cleaned with a cloth wrung out in hot soapy water.

Painted, plastic & metal finish parts (if fitted)

OVEN DOOR FRAME & HANDLE, GRILL PAN HANDLE, FACIA PANEL & CONTROL KNOBS

Only use a clean cloth wrung out in hot soapy water.

Burner caps and heads

Important: Allow burners to cool before cleaning.

Caution: Hotplate burners can be damaged by soaking, automatic dishwashers (or dishwasher powders / liquids), caustic pastes, hard implements, coarse wire wool, and abrasive cleaning pastes.

Clean with a moist soapy pad - eg; "Brillo".

For the burners to work safely, the slots in the burner head where the flames burn need to be kept clear of deposit. Clean with a nylon brush, rinse, and dry thoroughly.

Important: The burner caps and heads must be repositioned correctly so that they sit squarely onto the hob as shown.

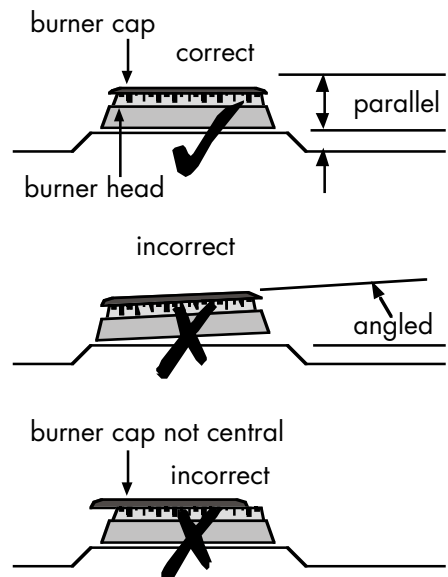

Cleaning

Enamel surfaces

OVEN CAVITIES

Caution: Most types of cleaning agent will damage these surfaces.

Only use a few drops of washing up liquid in hot water. Wipe the surfaces with a clean cloth wrung out in hot soapy water - if larger splashes of fat do not readily disappear, scrub the area with a nylon brush or nylon pan scourer and hot soapy water. Rinse well and heat the oven to dry the surfaces.

Vitreous Enamel parts

GRILL PAN, HOB TOP & PAN SUPPORTS.

Use a mild cream cleaner - eg; "Cif".

Stubborn marks may be removed with a moistened "Brillo" pad.

The pan supports and grill pan may be cleaned in a dishwasher, or with a nylon brush in hot soapy water.

Glass parts

GLASS DOOR PANELS, LID GLASS

Do not use abrasives or polishes as they will scratch and damage the glass.

Use a mild cream cleaner - eg; "Cif". Rinse away excess cleaner and dry with a soft cloth.

Warning: Do not operate the appliance without the glass panel correctly fitted.

Important: the inner door glass panel can be removed for cleaning but it must be replaced correctly (so the reflective side - if fitted - faces the rear

of the outer door glass panel), and pushed fully in to the **stop** position. To remove the glass panel, open the door wide, hold the top and bottom edges and slide out.

Chrome plated parts

OVEN SHELVES & OVEN SHELF RUNNERS, GRILL PAN TRIVET

Do not use abrasives or polishes, use a moist soap pad - eg; "Brillo".

Note: Oven shelf runners can be removed for cleaning. Grasp the runners, and slide out of the hanging holes as shown.

Note: These items may also be cleaned in a dishwasher.

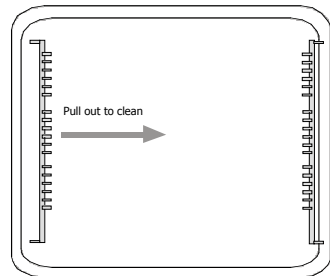

Installation Instructions

Before you start: Please read the instructions. Planning your installation will save you time and effort.

Prior to installation, ensure that the local distribution conditions (nature of the gas and gas pressure) and the adjustment of the appliance are compatible. The adjustment conditions are stated on the data badge.

This appliance is not connected to a combustion evacuation device. It shall be installed and connected in accordance with current installation regulation. Particular attention shall be given to the relevant requirements regarding ventilation.

In your own interest and that of safety, it is the law that all gas appliances be installed and serviced by competent persons. CORGI registered installers undertake to work to satisfactory standards.

Where regulations or standards have been revised since this handbook was printed, always use the latest edition.

In the UK the regulations and standards are as follows:

1. Gas Safety Regulations 1996 (Installation and Use).
2. Building Regulations - Issued by the Department of the Environment.
3. Building Standards (Scotland) (Consolidated) - Issued by the Scottish Development Department.
4. The current I.E.E. Wiring Regulations.
5. Electricity at Work Regulations 1989.
6. BS 6172 Installation of Domestic Gas Cooking Appliances

Also, for **LP Gas**, refer to BS 5482 Part 1, Part 2 or Part 3 as relevant.

7. Installation & Servicing Instructions for this appliance.

For installation in countries other than the UK, the appliance must be connected in accordance with all local gas and electrical regulations. In the Republic of Ireland, Installers should refer to IS813 Domestic Gas Appliances.

Ventilation Requirements

The room containing the appliance should have an air supply in accordance with BS 5440: Part 2: 1989:

- All rooms require an openable window, or equivalent, and some rooms will require a permanent vent as well.
- For room volumes up to 5m³ an air vent of 100cm² is required.
- If the room has a door that opens directly to the outside, or the room exceeds 10m³, NO AIR VENT is required.
- For room volumes between 5m³ and 10m³ an air vent of 50cm² is required.
- If there are other fuel burning appliances in the same room, BS 5440: Part 2: 1989 should be consulted to determine the air vent requirements.
- This appliance must not be installed in a bed sitting room of less than 20m³ or in a bathroom or shower room.

Windows and permanent vents should therefore not be blocked or removed without first consulting a CORGI gas installer.

LP Gas only - Do not install this appliance in a room below ground level. This does not preclude installation into rooms which are basements with respect to one side of the building, but open to ground level on the opposite side.

In the Republic of Ireland, refer to relevant Irish Standards for correct ventilation requirements.

Failure to install appliances correctly is dangerous and could lead to prosecution.

Installation Instructions

Whilst every care is taken to eliminate burrs and raw edges from this product, please take care when handling - we recommend the use of protective gloves during installation.

Moving the cooker

Please note that the weight of this appliance is approximately **60kg** (unpacked). Take care if the appliance needs to be lifted during installation - always use an appropriate method of lifting.

Do not attempt to move the cooker by pulling on the doors or handles. Open the door and grasp the frame of the cooker, taking care that the door does not shut on your fingers.

Take care to avoid damage to soft or uneven floor coverings when moving the appliance. Some cushioned vinyl floor coverings may not be designed to withstand sliding appliances without marking or damage.

Clearances & dimensions

Appliance dimensions

All sizes are nominal, and some variation is to be expected. The 'depth' of the cooker, as given below, is to the front of the door and excluding knobs and handles.

depth: 600mm

width: 550 or 600mm

height (adjustable): 900 - 915mm

height with lid raised: 1430 - 1445mm

Clearances

No shelf or overhang or cooker hood should be closer than a minimum of 650mm, but check with cooker hood manufacturer's recommendations.

The cooker must have a side clearance above hob level of 90mm up to a height of 400mm.

Check that there are no projections in the rear wall which will prevent the lid (where fitted) being raised to the vertical position.

This cooker may be fitted flush to base units. However, for models with side opening doors, we recommend a side clearance of 60mm between the cooker and any side wall.

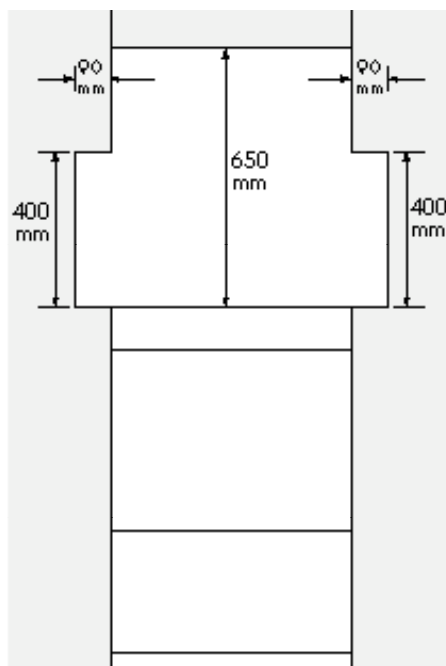

Installation Instructions

Stability bracket

If the cooker is fitted with a flexible connection, a stability bracket should be fitted to engage in the back of the cooker. A stability bracket can be bought from your local supplier.

A stability bracket can be fitted as follows:

1. Place the cooker in position and draw a PENCIL LINE level with the front edge.
2. Mark the centre of the cooker to give the CENTRE LINE for the bracket.
3. Remove the cooker and mark off 450mm from the PENCIL LINE to locate the front edge of the lower bracket.

4. Fix the bracket to the floor.

Measure from FLOOR LEVEL to ENGAGEMENT EDGE in the back of the cooker and add 3mm.

5. Assemble the underside of the top part of the bracket to this height.

Levelling

Place a spirit level on a baking sheet onto an oven shelf.

The cooker is fitted with levelling feet at the front and rear.

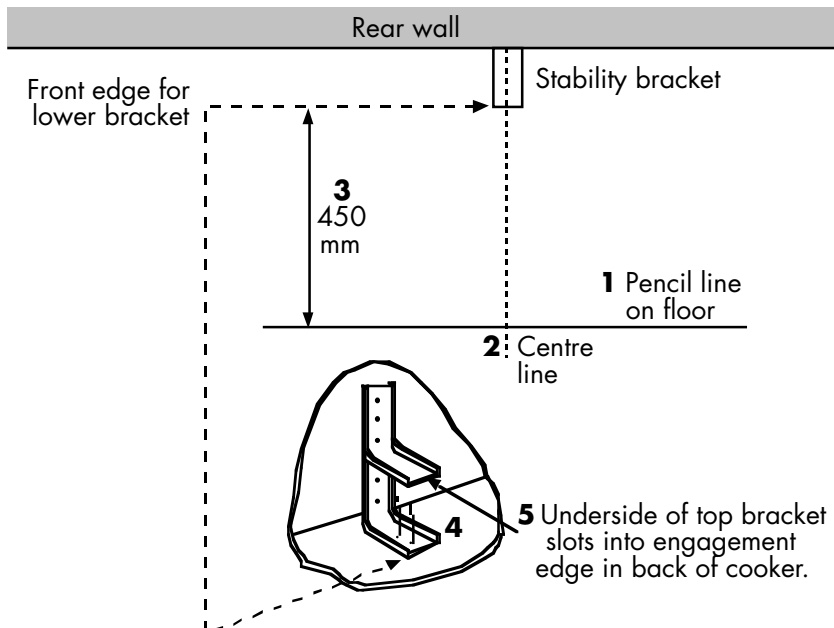

Installation Instructions

Connect to the electricity supply

Warning: This appliance must be earthed.

The flexible mains lead is supplied connected to a BS 1363 fused plug, having a fuse of 3 amp capacity.

If this plug does not fit the socket in your home, it should be replaced with a suitable plug as outlined below.

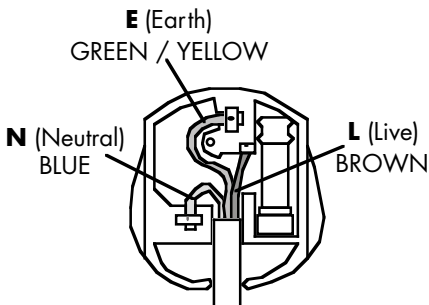

Use a **3 amp** fuse
in a 13 amp plug.

The wires in the mains lead are coloured in accordance with the following code:

Green and yellow = Earth,

Blue = Neutral,

Brown = Live.

As the colours of the wires in the mains lead for the appliance may not correspond with the coloured markings identifying the terminals in your plug, proceed as follows:

1. The wire which is coloured green and yellow must be connected to the terminal marked **E**  (Earth) or coloured Green.
2. The wire which is coloured blue must be connected to the terminal marked **N** (Neutral), or coloured Black.
3. The wire which is coloured brown must be connected to the terminal marked **L** (Live), or coloured Red.

The plug and socket must be accessible after installation.

Should the mains lead of the appliance ever require replacing, we recommend that this is carried out by a qualified electrician who will replace it with a lead of the same size and temperature rating.

Important: - ensure that you route all mains and electrical cables and flexible tubing well clear of any adjacent heat source.

Installation Instructions

Connect to the gas supply

The inlet to the cooker is ½" BSP internal situated at the rear right corner.

Fit the bayonet connection. This should be located so as to ensure that the flexible connector hose does not kink.

Use a 900mm - 1125mm length of flexible connector.

Ensure that all pipe work is of the correct rating for both size and temperature.

Natural Gas - Flexible connections should comply with BS 669. Parts of the appliance likely to come into contact with a flexible connector have a temperature rise of less than 70°C.

LP Gas - For flexible connections use a bayonet type hose, suitable for use on LP Gas up to 50 mbar pressure rise and 70°C temperature rise. The flexible hose should be coloured black with a red stripe, band or label. If in doubt, contact your supplier.

After installation, make sure all connections are gas sound.

Commissioning

Burner aeration

All burners have fixed aeration and no adjustment is possible.

Pressure setting

G20 Natural Gas @ 20 mbar

G30 Butane @ 28-30 mbar

G31 Propane @ 37 mbar

Pressure test point

Use the oven injector.

Grill - Open the top oven / grill door. Push in and turn the top oven / grill control knob clockwise to the 'FULL ON' position. Hold the control knob in, and press the ignition switch (if fitted) or hold a lighted match or taper to the burner, until the burner lights.

Hob burner - Turn the control knob to the FULL ON position, wait a second before pressing the ignition switch or holding a lighted match or taper to the burner.

Wok burner - Push in and turn the wok burner control knob to the 'simmer' position (*small flame symbol*) and press the ignition switch (if fitted) or hold a lighted match or taper to the burner, until it lights.

Ovens - Open the oven door. Turn the control to the FULL ON position and press the ignition switch, or hold a lighted match or taper to the burner. The burner operates at a low rate for up to 60 seconds until the flame supervision device opens & full gas rate is obtained.

Before leaving the installation

1. Place all the loose parts of the cooker into position.
2. Show the customer how to operate the cooker and give them this handbook. Thank you.

Technical Data

Data badge - Lower part of front frame

Type of gas - This cooker must only be used with either Natural Gas only or LP Gas only, as specified on the appliance data badge.

Gas category - Natural Gas - I2H, LP Gas - I3+

Pressure setting

G20 Natural Gas @ 20 mbar

G30 Butane @ 28-30 mbar

G31 Propane @ 37 mbar

Pressure test point - Use the oven injector

Aeration - Fixed

Appliance class - Class 1, freestanding

Grill - Grill burner is surface combustion

type. Spark gaps 3 - 4mm.

Hob - Burners have burner heads and caps which are removable for cleaning. Concealed electrodes to each burner.

Ovens - Oven burners are sheet steel, with pierced ports in stainless steel flame strip. *Spark Gap:* 3 - 4mm. *Flame supervision:* Expansion type. *Thermostat phial:* Front centre of oven roof.

Electrical supply

220 - 240V ~ 50Hz

Spark generator: Mains operated 7 outlet controlled by a single push button switch at the left hand side of the fascia to individual electrodes.

Warning: This cooker must be earthed.

Countries of destination - GB - Great Britain,

Technical Data

Gas	Burner	Nominal Rate Qn	Injector Size	Grammes per hour	
				Butane	Propane
Natural Gas	Grill	2.4kW	1.15 mm	-	-
	Hob - small	1.0kW	77	-	-
	Hob - medium	2.0kW	104	-	-
	Hob - large	3.0kW	129	-	-
	Hob - Wok (if fitted)	3.5kW	63 & 121	-	-
	Main Oven	2.5kW	180 Amal	-	-
	Top Oven	1.75kW	110 Amal	-	-
	<i>Max. heat input Without Wok</i>	Qn 12.9kW	-	-	-
	<i>Max heat input With Wok</i>	Qn 13.4kW	-	-	-
LP Gas	Grill	2.4kW	0.76 mm	175g/h	172 g/h
	Hob - small	1.0kW	50	73g/h	71g/h
	Hob - medium	2.0kW	70	145g/h	143g/h
	Hob - large	3.0kW	87	218g/h	214g/h
	Hob - Wok (if fitted)	3.5kW	35 & 87	255g/h	250g/h
	Main Oven	2.4kW	70 Amal	175g/h	172g/h
	<i>Max. heat input Without Wok</i>	Qn 12.8kW	-	931g/h	915g/h
	<i>Max heat input With Wok</i>	Qn 13.3kW	-	967g/h	950g/h

Contact Us

Should you need to get in touch with us (UK and Northern Ireland only), please call Belling Customer Care Centre Helpline on:

0871 22 22 503

For customers outside the UK and Northern Ireland, please contact your local supplier.

When you dial this number you will hear a recorded message and be given a number of options. This indicates that your call has been accepted and is being held in a queue. Calls are answered in strict rotation as our Customer Care Representatives become available.

Enter appliance numbers here for future reference:

Model No									
Serial No									

Please ensure you have the above details (Model No and Serial No) to hand when calling Belling Customer Care. They are essential to booking your call.



Glen Dimplex Home Appliances Limited is the owner of the Belling brand and is part of the Glen Dimplex group of companies.

08 27310 01 © 05.2007

Gas Double Oven

Model Names: G774, G775, G778, G772