

Whatever the occasion

bellin[®]

think of everything

CONTENTS

User Section	2 - 30
Introduction	2
Be Safe - Not Sorry.	4
Using the Hob	5
Choice of pans.	7
Using the Grills.	9
Using the Top Oven	11
Top Oven baking guide	12
Using the main oven	13
Oven furniture	14
Cooking in the fanned oven.	15
Defrosting and cooling	16
Main oven conversion guide	17
Baking guide	18
Traditional fruit cakes	19
Roast turkey	19
Roasting guide	20
Minute minder	21
Care and cleaning	22
Installation Instructions	25
Technical Data	27
Belling Customer Care	back cover

Please keep this handbook for future reference, or for anyone else who may use the appliance.

INTRODUCTION

Thank you for choosing a British built appliance by Belling.

We hope that the following information will help you to quickly familiarise yourself with the features of the appliance, and to use it successfully and safely.

Our policy is one of constant development and improvement. Strict accuracy of illustrations and specifications is not guaranteed. Modification to design and materials may be necessary subsequent to publication.

This cooker may be sited with cabinets on both sides, or it may be free standing. Sufficient space should be allowed at either side of the cooker to enable it to be pulled out for cleaning and servicing.

Please read the instructions in this handbook before using or installing this appliance. All installation and servicing work must be carried out by a competent person.

Your 1st Year Guarantee

To fulfil the conditions of your guarantee, this appliance must be correctly installed and operated, in accordance with these instructions, and only be used for normal domestic purposes.

Please note that the guarantee, and Service availability, are only available in the UK and Republic of Ireland.

Moving the cooker

Do not attempt to move the cooker by pulling on the doors or handles. Open the oven or grill door and grasp the frame of the cooker, taking care that the door does not shut on your fingers.

Take care to avoid damage to soft or uneven floor coverings when moving the appliance. Some cushioned vinyl floor coverings may not be designed to withstand sliding appliances without marking or damage.

Before using the appliance for the first time, remove any protective polythene film and wash the oven shelves and shelf runners in hot soapy water to remove their protective coating of oil. Even so, when you first turn on the oven or grill you may notice a smell and some smoke.

Glass door panels

To meet the relevant Standards of Domestic cooking appliances, all the glass panels on this appliance are toughened to meet the fragmentation requirements of BS3193. This ensures that, in the likely event that a panel breaks, it does so into small fragments to minimise the risk of injury.

Please take care when handling, using or cleaning all glass panels, as any damage to the surfaces or edges may result in the glass breaking without warning or apparent cause at a later date. Should any glass panel be damaged, we strongly recommend that it is replaced immediately.

INTRODUCTION

The cooling fan

When the top oven, grill or hob are in use, you will hear the cooling fan come on. This keeps the fascia, control knobs and components cool during cooking.

Top oven/grill: The cooling fan will continue to operate for a period of time after the top oven/grill has been switched off.

Hob only: The cooling fan will not continue to operate after the hob has been switched off.

When hot and cold air meet, condensation forms. Some condensation may form on doors or on the fascia glass. This is normal and will disappear within 10 - 15 minutes.

Environmental Protection

We are committed to protecting the environment and operate an Environmental Management System which complies with BS EN ISO 14001:1996.

Disposal of packaging

- All our packaging materials are recyclable and environmentally friendly.
- Please help us to protect our environment by disposing of all packaging in an environmentally friendly manner.
- Please contact your local authority for the nearest recycling centre.

Caution: Packaging materials can pose a risk of suffocation - keep away from children.

Electrical connection

Please refer to installation instructions for electrical connection.

In your own interest, and that of safety, make sure that the installation is carried out by a competent person.

Disconnection of electric appliances should always be carried out by a competent person.

Warning: This appliance must be earthed.

To replace an oven light bulb

Caution: Switch off the electricity supply to the cooker at the socket, to avoid the risk of electric shock.

Wait until the oven is cool, then remove the shelves.

The oven light is at the rear of the oven cavity.

Remove the loose oven back - unscrew the 4 securing screws (one at each corner).

Unscrew the lens cover (turn anticlockwise). Unscrew the bulb and replace. Replace lens cover.

Replace oven back.

Please note that the oven light bulb is not covered by the guarantee. Replacement bulbs can be ordered from your local supplier, or bought from a hardware store.

BE SAFE - NOT SORRY

When you are cooking, keep children away from the vicinity of the appliance.

This product is designed as a domestic cooking appliance for the preparation and cooking of domestic food products, and should not be used for any other purpose.

- Make sure you read and understand the instructions before using the appliance.
- Remove all packaging, protective films and oils from the appliance before using for the first time.
- Keep electrical leads short so they do not drape over the appliance or the edge of the worktop.
- Keep all flammable materials (such as curtains, furnishings & clothing) away from the appliance.
- Never use the appliance for heating a room.
- Parts of the appliance may be hot during or immediately after use. Care should be taken to avoid touching heating elements inside the oven. Allow sufficient time for the appliance to cool after switching off.
- Do not use the oven with the door inner glass panel removed.
- Do not drape tea towels over the flue vents or doors, as this creates a fire hazard.
- Switch off the electricity supply before replacing the oven light bulb, to avoid the risk of electric shock.
- Do not use aluminium foil to cover the grill pan, or put items wrapped in foil under the grill, as this creates a fire hazard. The high reflectivity can also damage the element.
- Do not use foil on oven shelves, or allow it to block the oven flue, as this creates a fire hazard, and prevents heat circulation.
- When cooking heavy items - eg; turkeys - do not pull the oven shelf out with the item still on the shelf.
- When opening the appliance door, take care to avoid skin contact with any steam which may escape from the cooking.
- Use oven gloves when removing hot food / dishes from the oven or grill. The oven / grill and utensils will be very hot when in use.
- **Warning:** This appliance must be earthed.
- All installation, servicing and maintenance work should be carried out by a competent person who will comply with current Regulations, Standards and Requirements.
- **When you have finished cooking check that all controls are in the off position.**

USING THE HOB

Warning: Do not use the ceramic hob if the glass surface is cracked, as electrical parts are immediately beneath. Switch off the appliance at the supply to prevent electric shock and contact your supplier.

Before using the hob for the first time

Before using the hob for the first time, apply a thin coating of cleaner conditioner and polish the surface with a clean dry cloth.

The conditioner gives a protective covering to the ceramic glass which not only makes the hob easier to clean, but also ensures you will gain maximum life out of this product.

Using the hotplate elements

To switch on, turn the control knob for the selected hob element to the desired setting.

Note: The marked settings on the hob controls do not indicate any set temperature and cannot be used to compare the performance of one ring with another.

The hob rings will cycle on and off automatically during use as a means of regulating heat output.

To switch off, return the control knob to the "off" position.

The hot hob light

The hob light comes on when one of the rings is switched on, and will stay on for a while after the last ring is switched off, to indicate that the hob glass may still be warm.

Cooling fan

The cooling fan will run while the hob is in use, but will stop once the hob has been switched off.

Care and cleaning

See 'Cleaning the Hob' section.

USING THE HOB

Using the hotplate

- Commercial simmering aids should not be used as they create excessive temperatures that can damage the surface and may cause a hazard.
- Do not place aluminium foil or plastic utensils on the ceramic glass, as they may melt and damage the surface.
- Do not use the ceramic glass hotplate surface for storage.
- When cooking with fat or oil, never leave unattended.
- Turn pan handles to a safe position, so they are out of reach of children, not overhanging the appliance, and cannot be caught accidentally.
- Position pans over the centre of the hotplate elements.
- Do not use the hob as a chopping board or a storage area, as this increases the likelihood of it being damaged - eg; plastic utensils placed on a warm hob may melt onto it, and damage the ceramic glass surface.
- Aluminium foil must not be placed on the hob as it will reflect any heat back into the element, which can damage it.
- Leaving a hotplate on for a length of time, without it being covered by a pan, causes overheating of surrounding areas which could damage the glass.
- Be careful when cooking foods in salted water, or foods containing large amounts of sugar, syrup or jam - if they are spilt onto hot areas of the hob they may damage it.
- Lift pans onto and off the surface, rather than sliding them across the surface, to avoid marks and scratches.
- If you use a wet paper towel to remove spills from a warm heating area of the hob, be careful to avoid steam burns.
- Do not use abrasive powder cleaners, metal wire wool pads, impregnated plastic pads, detergents, bleaches, bath stain removers, or chemical oven cleaners; all these types of products will damage the ceramic glass.

USING THE HOB

To save energy

- Always position pans centrally over the heating area.
- Put lids on saucepans and only heat the amount of liquid you need.
- When liquids boil, reduce the control setting to maintain a simmer.
- Consider the use of a pressure cooker for the cooking of a complete meal.
- Vegetables will cook quicker if chopped in smaller pieces.
- Larger heating elements are ideal for faster cooking methods, such as boiling or frying, and for larger pans. Smaller heating elements are ideal for simmering and stewing, and for smaller pans.
- Do not use a pan which is too small or too large for the heating area - refer to notes on next page.

Choice of pans

The choice of cookware is important if you are to achieve maximum benefit from cooking with a ceramic hob.

Ceramic hobs are not only easy to clean, they are also energy efficient if you use the right pans to suit the surface.

When buying new pans, always refer to the manufacturer's guidelines.

For best results and energy efficiency, it is important to use flat bottomed pans of the correct type, especially on ceramic glass hobs.

Always use pans which are large enough to prevent spillage, especially for deep frying, or when cooking with a sugar based substance.

Trivets, round based woks, heat diffuser pads and over-sized pans are not recommended.

Do not use double pans, rim based pans, old misshapen pans or any pan which is unstable when placed on a flat surface.

USING THE HOB

Type and size of pan

- Cast iron, stainless steel, or enamelled steel pans are all suitable for use on ceramic glass hobs.
- Aluminium pans will give good cooking results but care must be taken in their use. If they are slid across the surface of the hob they tend to leave visible marks which can be difficult to remove.
- Certain makes / brands of pressure cookers may not be suitable for use on ceramic hobs - they do not come to pressure. Stainless steel pressure cookers will give optimum results.
- Glass pans can be used but the glow from the heating areas transmitted through transparent glass may cause some visual discomfort.
- Avoid using double pans or old misshapen pans which are unstable and dangerous.
- Certain types of copper based pans may become slightly concave when heated, which can result in slower cooking times.
- Always use pans which are large enough to avoid overflows onto the ceramic hob, especially if a pan contains any sugar / sugar based substance, as this is corrosive and can damage the ceramic glass surface.
- Pan bases should be thick, flat, and smooth, to ensure maximum contact with the hob, maximum heat conduction and rapid cooking times.
- Pans with dull or dark coloured bases will give the quickest cooking results.
- Pans with highly polished bases can reflect heat back into the hob causing the hotplate to cycle on and off more rapidly than normal, which can slow down cooking.
- Pans with thin, dented or ridged bases should not be used. They will not make maximum contact with the hob, which can result in very slow cooking times.
- The right size of pan base will ensure maximum contact with the hob and rapid cooking times.
- Use pans with a flat base of minimum 100mm / 4" diameter and maximum 280mm / 11" diameter which are stable in use.
- Pan bases that are much smaller or much larger than the hotplate - eg; by 50mm / 2" - will result in slower cooking times.

USING THE GRILL

Caution: Accessible parts may be hot when the grill is used, young children should be kept away.

Detachable grill pan handle

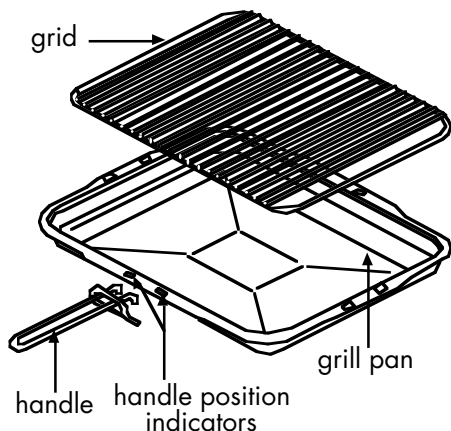

Place the handle over the edge of the grill pan, at the narrow side edges. Slide the handle to the centre, and locate between the handle position indicators.

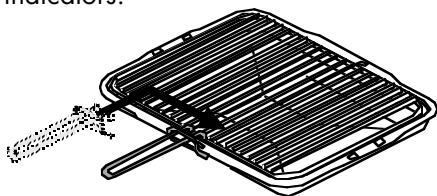

The handle should be removed from the pan during grilling, to prevent overheating.

The handle is designed for removing / inserting the grill pan under the grill when grilling.

If cleaning the grill pan when it is hot, use oven gloves to move it. *Do not* use

the handle to pour hot fats from the grill pan.

Food for grilling should be positioned centrally on the trivet.

Aluminium foil

Using aluminium foil to cover the grill pan, or putting items wrapped in foil under the grill can create a fire hazard, and the high reflectivity can damage the grill element.

The cooling fan

When the grill is switched on, you will hear the cooling fan come on - this keeps the fascia and control knobs of the appliance cool during grilling. The fan will continue to operate for a period after the grill control has been switched off.

USING THE GRILL

Using the grill

Caution: Accessible parts may be hot when the grill is used, young children should be kept away.



The top oven grill is a fully variable dual element grill.

Preheating

For best results, preheat the grill for 3 - 5 minutes.

To switch on the grill

Open the top oven / grill door.

Turn the top oven control knob past the oven temperature markings to either the single economy grill  symbol, or the dual grill  symbol.

The grill regulator - to the left of the top oven control - must then be switched on. This enables variation of the heat output from the grill on either the single grill or dual grill settings.

The dual grill uses all of the top element, and the single economy grill setting uses the inner part of the element only.

Important: The door must be kept open when the grill is used.

To switch off, return the control knobs to the "off" position.

Note that the grill will not operate if the top oven is switched on.

For grilling smaller quantities of food the (single element) economy grill can be utilised. This grill function can be controlled between settings 1 and 8.

For grilling larger quantities of food, the (dual element) full grill can be utilised. The full grill can also be controlled between settings 1 and 8.

When using the grill in the top oven, the speed of grilling can be controlled by use of either the variable control or by selecting higher or lower shelf position.

For toasting, and for grilling foods such as bacon, sausages or steaks, use a higher shelf position.

For thicker foods such as chops or chicken joint pieces, use a middle to low shelf position.

USING THE TOP OVEN

When you are cooking keep children away from the vicinity of the oven.

Caution: The top element gets extremely hot when in use, so take extra care to avoid touching it.

The top oven is a conventional oven

Note: The top oven is not controlled by the programmer.

To turn on the top oven

Turn the temperature control knob clockwise until the required temperature is selected.

The red thermostat indicator will come on until the selected temperature is reached, and then go off; it will turn on and off periodically as the thermostat operates to maintain the selected temperature.

To switch off, return the top oven control knob to the off position.

Important: Never put items directly on the base of the oven, or cover the oven base with foil, as this may cause the element to overheat. Always position items on the shelf.

The cooling fan

When the top oven is switched on, you will hear the cooling fan come on - this keeps the fascia and control knobs of the appliance cool during cooking. The fan will continue to operate for a period after the oven control has been switched off.

Preheating

The oven must be preheated when

cooking frozen or chilled foods, and we recommend preheating for yeast mixtures, batters, soufflés, and whisked sponges.

Preheat the oven until the indicator light switches off for the first time, this will take up to 20 minutes depending on the temperature selected.

If you are not preheating the oven, the cooking times in the following guide may need to be extended, as they are based on a preheated oven.

Shelf positions

There are 5 shelf positions which are counted from the bottom of the oven upwards, so shelf position 1 is the lowest.

When cooking frozen or chilled food, use the highest possible shelf position, while allowing some clearance between the food and the top element.

The oven shelf must be positioned with the upstand at the rear of the oven and facing up. Position baking trays and roasting tins on the middle of the shelves, and leave one clear shelf position between shelves, to allow for circulation of heat.

When using the top oven

As part of the cooking process, hot air is expelled through a vent at the top of the oven(s). When opening the oven door, care should be taken to avoid any possible contact with potentially hot air, since this may cause discomfort to people with sensitive skin. We recommend that you hold the underneath of the oven door handle.

Using the Top Oven

Top oven baking guide

Cooking times

These times are based on cooking in a preheated oven.

These cooking times are approximate, because the size and type of cooking dish will influence time as personal preferences.

Shelf positions

As a general guide, when cooking frozen or chilled food, use the highest possible shelf position, while allowing some clearance between the food and the top element. Follow the instructions given on packaging.

Cooking temperatures

The temperature settings and time given in the Baking Guides are based on dishes made with block margarine. If soft tub margarine is used, it may be necessary to reduce the temperature setting. If a recipe gives a different temperature setting to that shown in the guide, the recipe instruction should be followed.

Because the top oven is more compact, it may be necessary to reduce cooking temperatures specified in recipes by up to 20°C.

Use the baking guide as a reference for determining which temperatures to use.

Item	Temperature °C	Shelf position	Approximate cooking time
Small cakes	180	middle	15 - 20 mins
Victoria sandwich (2 x 180mm / 7")	160	middle	20 - 25 mins
Swiss roll	200	middle	8 - 12 mins
Semi rich fruit cake (180mm x 7")	140	bottom	2¼ - 2¾ hours
Scones	215	top	10 - 15 mins
Meringues	90 - 100	bottom	2 - 3 hours
Shortcrust pastry	200 - 210	middle	Depends on size & type of cooking dish & also the filling
Puff / flaky pastry	200 - 210	middle	
Choux pastry	200 - 210	middle	
Biscuits	160 - 200	top	10 - 20 mins
Sponge pudding	150	middle	30 - 45 mins
Milk pudding	140	bottom	2 - 2½ hours

Using the Main Oven

Accessible parts may be hot when the oven is used. Young children should be kept away.

To switch on the oven

Turn the oven control knob clockwise to the required setting.

The red thermostat indicator will come on until the selected temperature is reached and then go off; it will turn on and off periodically as the thermostat operates to maintain the selected temperature.

To switch off, return the control knob to the "off" position.

When using the oven

As part of the cooking process, hot air is expelled through a vent at the rear of the oven. When opening the oven door, care should be taken to avoid any possible contact with potentially hot air, since this may cause discomfort to people with sensitive skin. We recommend that you hold the underneath of the oven door handle.

Preheating

When cooking sensitive items such as soufflé and Yorkshire puddings or, when cooking bread, we recommend that the oven is pre-heated until the neon switches off for the first time. For any other types of cooking, a pre-heat is not required.

Using the Main Oven

Oven furniture

Oven shelves

The oven shelf must be positioned with the upstand at the rear of the oven and facing upwards.

Position baking trays and roasting tins on the middle of the shelves, and leave one clear shelf position between shelves, to allow for circulation of heat.

Baking tray and roasting tins

For best cooked results and even browning, the maximum size baking trays and roasting tins that should be used are as follows;

Baking tray 350mm x 280mm

This size of baking tray will hold up to 16 small cakes.

Roasting tin 370mm x 320mm

We recommend that you use good quality cookware. Poor quality trays and tins may warp when heated, leading to uneven baking results.

Slow cooking

- Make sure that frozen foods are thoroughly THAWED before cooking.
- Do not slow cook joints of meat or poultry weighing more than 2¼kg / 4½lb.
- For roasting joints of meat or poultry, and for pot roasts preheat the oven to 160°C and cook for 30 minutes, then adjust the oven control to the 110°C - 120°C (slow setting) for the remainder of the cooking time.
- Slow cooking times will be about 3 times as long as conventional cooking times.
- Do not open the oven door unnecessarily during slow cooking, as this will result in heat loss at low temperatures.
- Always use dishes with tightly fitting lids. To rectify badly fitting lids, place foil over the dish underneath the lid.

Aluminium foil

Use foil only to cover food or cooking dishes, using foil to cover the shelves or oven base creates a fire hazard.

Using the Main Oven

Cooking with a fanned oven

As this is a high efficiency oven, you may notice the emission of steam from the oven when the door is opened. Please take care when opening the door.

If you are used to cooking with a conventional oven you will find a number of differences to cooking with a fan oven which will require a different approach:

There are no zones of heat in a fan oven as the convection fan at the back of the oven ensures an *even temperature* throughout the oven. This makes it ideal for batch baking - eg; when planning a party or stocking the freezer - as all the items will be cooked within the same length of time.

Foods are cooked at a *lower temperature* than a conventional oven, so conventional recipe temperature may have to be reduced. Please refer to the conversion chart.

Preheating is generally not necessary as a fan oven warms up quickly.

There is no flavour transference in a fan oven, which means you can cook strong smelling foods such as fish at the same time as mild foods - eg; milk puddings.

When batch baking foods that will rise during cooking - eg; bread - always ensure that enough space has been left between the shelves to allow for the rise.

Notes:

When 2 or more shelves are being used, it may be necessary to increase the cooking time slightly.

Because the 2 oven shelves are wider than in many ovens, it is possible to cook 2 items per shelf - eg; 2 victoria sandwiches or 2 casseroles.

Although you need to keep in mind the points '*To help the air circulate freely*' with careful choice of dishes and tins, it is possible to cook a complete meal, and perhaps something else for the freezer, in the oven at the same time.

When roasting meats, you will notice that fat splashing is reduced, which is due in part to the lower oven temperatures, and will help keep cleaning of the oven to a minimum.

Because a fan oven has an even temperature throughout the oven, there is no need to follow the shelf positions given in the baking guide. There is no need to interchange dishes onto different shelves part way through cooking, as with a conventional oven.

To help the air circulate freely

Position the shelves evenly within the oven and maintain a clearance from the oven roof and base.

If more than one cooking dish or baking tray is to be used on a shelf, leave a gap of at least 25mm between the items themselves and the oven interior.

Using the Main Oven

Defrosting and cooling in the main oven

To **defrost** frozen foods, turn the main oven control to the defrost position, place the food in the centre of the oven and close the door.

To **cool** foods after cooking prior to refrigerating or freezing, turn the main oven control to the defrost position and open the door.

Defrosting times

Small or thin pieces of frozen fish or meat - eg; fish filets, prawns & mince will take approximately 1 - 2 hours.

Placing the food in a single layer will reduce the thawing time.

A medium sized casserole or stew will take approximately 3 - 4 hours.

A 1½kg / 3lb oven ready chicken will take approximately 5 hours, remove the giblets as soon as possible.

Be safe

Do not defrost stuffed poultry using this method.

Do not defrost larger joints of meat and poultry over 2kg / 4lb using this method.

Never place uncooked food for defrosting next to cooked food which is to be cooled, as this can lead to cross contamination.

Defrosting meat, poultry, and fish can be accelerated using this method but make sure they are completely thawed before cooking thoroughly. Place meat and poultry on a trivet in a meat tin.

Main oven baking guide

Cooking times & temperatures

The temperature settings and times given in the baking guide are based on dishes made with block margarine. If soft tub margarine is used it may be necessary to reduce the temperature setting.

MAIN OVEN CONVERSION GUIDE

Note: this is a high efficiency oven, therefore some adjustment will have to be made to **conventional** cooking temperatures. The table below shows conventional cooking temperatures, 'A' efficiency temperatures and gas marks. For optimum results, conventional temperatures need to be converted to 'A' efficiency temperatures.

For example, an item which would normally cook at a conventional temperature of 180 °C, will now cook at the 'A' efficiency temperature of 160°C.

Conventional temperature (°C)	'A' Efficiency Oven (°C)	Gas Mark
100	100	1/4
110	110	1/4
130	120	1/2
140	130	1
150	140	2
160	150	3
180-190	160	4-5
200	170	6
220	180	7
230	190	8
250	200	9

USING THE OVENS

Baking guide

Dish	Recommended temperature °C	Approximate cooking time (preheated oven)
Scones Meringues	180 110	8 - 15 2 - 3hrs
Cakes Small cakes Whisked sponge Swiss roll Victoria sandwich (2 x 180mm / 7") Genoese sponge Madeira (180mm / 7") Semi rich fruit cake (205mm / 8") Christmas cake (205mm / 8") Dundee cake (205mm / 8")	160 160 170 160 160 160 130 depending on recipe 130	15 - 25mins 15 - 20 mins 10 - 12 mins 20 - 30 mins 20 - 25 mins 1hr - 1¼ hrs 2½ - 3hrs depending on recipe 2½ - 3hrs
Pastry Flaky / Puff Shortcrust Choux Plate tarts (2 x 180mm / 7")	180 170 170 170	depending on recipe and type of filling
Biscuits Shortbread rounds Nut brownies Brandy snaps Flapjacks Ginger nuts	160 170 160 160 160	20 - 25 mins 20 - 25 mins 10 - 12 mins 20 - 25 min 10 - 20 mins

Using the Ovens

Traditional fruit cakes

It should be remembered that ovens can vary over time, therefore cooking times can vary, making it difficult to be precise when baking fruit cakes.

It is necessary therefore, to test the cake before removal from the oven. Use a fine warmed skewer inserted into the centre of the cake. If the skewer comes out clean, then the cake is cooked.

- Follow the temperatures suggested in the recipe and then adjust accordingly to the conversion table on page 12.
- Do not attempt to make Christmas cakes larger than the oven can cope with, you should allow at least 25mm (1 inch) space between the oven walls and the tin.
- Always follow the temperatures recommended in the recipe.
- To protect a very rich fruit cake during cooking, tie 2 layers of brown paper around the tin.
- We recommend that the cake tin is not stood on layers of brown paper, as this can hinder effective circulation of air.
- Do not use soft tub margarine for rich fruit cakes, unless specified in the recipe.
- Always use the correct size and shape of tin for the recipe quantities.

Roast turkey

Roasting turkey involves cooking two different types of meat - the delicate light breast meat, which must not be allowed to dry out, and the darker leg meat, which takes longer to cook.

The turkey must be roasted long enough for the legs to cook, so frequent basting is necessary. The breast meat can be covered once browned.

- Always make sure that the turkey is completely thawed and that the giblets are removed before cooking.
- Turkey should be roasted at 150°C - 160°C for 20 minutes per lb, plus 20 minutes, unless packaging advises otherwise.
- The turkey can be open roasted, breast side down, for half of the cook time, and then turned over for the remainder of the cooking time.
- If the turkey is stuffed, add 5 minutes per 1lb to the cooking time.
- If roasting turkey covered with foil, add 5 minutes per 1lb to the cooking time.

To test if the turkey is cooked, push a fine skewer into the thickest part of the thigh. If the juices run clear, the turkey is cooked. If the juices are still pink, the turkey will need longer cooking.

Using the Ovens

Roasting guide

The times given in the roasting guide are only approximate, because the size and age of the bird will influence cooking times as will the shape of a joint and the proportion of the bone.

Frozen meat should be thoroughly thawed before cooking. For large joints it is advisable to thaw overnight.

Frozen poultry should be thoroughly thawed before cooking. The time required depends on the size of the bird - eg; a large turkey may take up to 48 hours to thaw.

Use of a trivet with a roasting tin will reduce fat splashing and will help to keep the oven interior clean. Alternatively, to help reduce fat splashing, potatoes or other vegetables can be roasted around the meat / poultry.

Notes:

- When cooking stuffed meat or poultry calculate the cooking time from the total weight of the meat plus the stuffing.
- For joints cooked in foil or covered roasters, and for lidded casseroles, add 5 minutes per 450g (1lb) to the calculated cooking time.
- Smaller joints weighing less than 1.25kg (2½lb) may require 5 minutes per 450g (1lb) extra cooking time.
- Position the oven shelf so that the meat or poultry will be in the centre of the oven.
- It is recommended that the appliance is cleaned after open roasting. Allow the appliance to cool before attempting to clean it.

Cook in oven at: 160°C - Main Oven (Fanned) 180°C - Top Oven (Conventional)		Approximate Cooking Time (preheated oven)
Beef	Rare Medium Well done	20 minutes per 450g (1lb), plus 20 minutes 25 minutes per 450g (1lb), plus 20 minutes 30 minutes per 450g (1lb), plus 30 minutes
Lamb	Medium Well done	25 minutes per 450g (1lb), plus 25 minutes 30 minutes per 450g (1lb), plus 30 minutes
Pork		35 minutes per 450g (1lb), plus 35 minutes
Poultry		20 minutes per 450g (1lb), plus 20 minutes

Minute Minder (if fitted)

Initial display

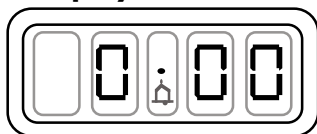

Minus button



Function select



Plus button

The digital timer enables you to set the time of day (24 hour clock) and the minute minder alarm.

Setting the time of day

1. Switch on the electricity supply to the appliance.
2. Press and release the function button.
3. Set the time of day, using the *plus* and *minus* buttons.
4. The time will be set 7 seconds after the last *plus* or *minus* operation.

Changing the time of day

1. Press the function button once.
2. Set the time of day, using the *plus* and *minus* buttons.
3. The time will be set 7 seconds after the last *plus* or *minus* operation.

Alarm tones

After setting the time of day, you can select one of three alarm tones.

Press the *minus* button to listen to the first tone, then release the *minus* button

and press again to listen to the second tone, etc.

Releasing the *minus* button after a tone has sounded will automatically select that tone.

Setting the minute minder

1. Press and release the *plus* button, to change the display from clock to minute minder - the bell symbol will light.
2. Use the *plus* and *minus* buttons to set the length of time before the alarm tone will sound. The display will increase / decrease in units of 10 seconds up to 99 minutes, 50 seconds, and in units of 1 minute from 1 hour 40 minutes upwards. The maximum period which may be set is 10 hours.

The display format will change after 99 minutes and 50 seconds to 1 hour and 40 minutes.

During countdown, the minute minder has priority on the display, which will show (in *minutes : seconds*, or *hours : minutes*) the time remaining.

When countdown is complete, the tone will sound for 7 minutes, or it can be reset with one touch of any button.

To cancel the minute minder at any time.

Run down the set time with the *minus* button. The display will show the time of day

CARE & CLEANING

Caution: Any cleaning agent used incorrectly may damage the appliance.

Always let the appliance cool before cleaning.

Do not use a steam cleaner on this appliance.

Some cooking operations generate considerable amount of grease, this combined with spillage can become a hazard if allowed to accumulate on the appliance through lack of cleaning. In extreme cases this may amount to misuse of the appliance and could invalidate your guarantee.

It is recommended that the appliance is cleaned after open roasting.

Do not use caustic, corrosive or abrasive cleaning products, products containing bleach, coarse wire wool or any hard implements, as they will damage the surfaces.

All parts of the appliance can be safely cleaned with a cloth wrung out in hot soapy water.

Vitreous enamel parts

GRILL PAN, TOP OVEN / GRILL COMPARTMENT,
MAIN OVEN COMPARTMENT FLOOR

Use a mild cream cleaner - eg; "Cif".

Look for one which has the Vitreous Enamel Development Council's recommendation seal.

Stubborn marks may be removed with a moistened "Brillo" pad.

The grill pan may be cleaned in a

dishwasher, or with a nylon brush in hot soapy water.

Easy care surfaces

MAIN OVEN SIDES AND BACK

We recommend that the appliance is cleaned after open roasting, and also after roasting at temperatures higher than 200°C, to help prevent a build up of fats. Use of a trivet in a roasting tin when roasting will help reduce fat splashing.

Caution: Most types of cleaning agent will damage these surfaces.

Only use a few drops of washing liquid in hot water. Wipe the surfaces with a clean cloth wrung out in hot soapy water - if larger splashes of fat do not readily disappear, scrub the area with a nylon brush or nylon pan scourer and hot soapy water. Rinse well and heat the oven to dry the surfaces.

CARE & CLEANING

Glass parts

FACIA PANEL, DOOR PANELS

Use a mild cream cleaner - eg; "Cif". Rinse thoroughly and dry with a soft cloth.

Important: The inner door glass panel(s) can be removed for cleaning, but they must be replaced the right way (so the reflective side faces inwards) and also pushed fully in to the stop position. To remove the glass panel, open the door wide, hold the edges of the glass and slide out.

Painted, plastic and metal finish parts (if fitted)

CONTROL KNOBS, DOOR HANDLES & DOORS, FASCIA PANEL

Only use a clean cloth wrung out in hot soapy water.

Chrome plated parts

OVEN SHELVES & OVEN SHELF RUNNERS, GRILL PAN TRIVET

Do not use abrasives or polishes, use a moist soap pad - eg; "Brillo".

Note: Oven shelf runners can be removed for cleaning. Grasp the runners, and slide out of the hanging holes as shown.

Note: These items may also be cleaned in a dishwasher.

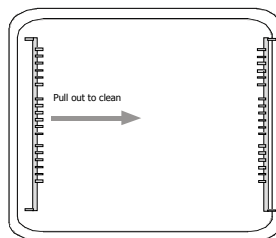

CARE & CLEANING

Cleaning the hob

Ceramic glass surface

Do not use abrasive powder cleaners, "Brillo" pads, metal wire, detergents, bleaches, bath stain removers, or chemical oven cleaners; all these product types will damage the ceramic glass.

The following recommendations will help to keep the ceramic glass surface bright and clean.

Allow the hob to cool.

Use a dampened paper towel or clean damp cloth to apply a small dab of cleaner conditioner to clean each heating area.

Use another paper towel or a clean dry soft cloth to wipe dry, and then polish the whole glass surface.

To remove any stubborn marks or heavy soiling, a non scratching, mild cream cleaner may be used - eg; "Cif".

Important: If you use a wet paper towel or clean damp cloth to remove spillage from a warm heating area of the hob, be careful to avoid steam burns.

Care and maintenance

Before using the hob for the first time, apply a thin coating of cleaner conditioner (eg; "Hob Brite", by Homecare*) to the ceramic glass only, and polish the surface with a clean cloth.

The conditioner gives a protective covering to the ceramic glass which not only makes the hob easier to clean, but also ensures that you will

gain maximum life out of this product. Occasional use will help prevent the build up of mineral deposits which can cause discolouration of the hob surface.

Discolouration of the hob

Do not use a dishcloth or dish sponge to wipe the hob - this can leave a film of detergent on the surface which will discolour the hob next time a heating area is used. Clean cloths kept for the cleaning of the hob can be used.

Do not use too much cleaner conditioner - only a thin coating is required, any excess may burn on and discolour the hob when it is next in use.

If persistent stains or marks remain on the ceramic glass surface, it can be cleaned using a mild cream cleaner - eg; "Cif", or a ceramic hob scraper. This will also remove any accumulated salts or minerals before they have an opportunity to discolour the ceramic glass.

Wipe clean with a damp paper towel or clean damp cloth and re-apply cleaner conditioner.

INSTALLATION INSTRUCTIONS

Whilst every care is taken to eliminate burrs and raw edges from this product, please take care when handling - we recommend the use of protective gloves during installation.

Moving the cooker

Please note that the weight of this appliance is approximately **60kg** (unpacked). Take care if the appliance needs to be lifted during installation - always use an appropriate method of lifting.

Do not attempt to move the cooker by pulling on the doors or handles. Open the door and grasp the frame of the cooker, taking care that the door does not shut on your fingers.

Take care to avoid damage to soft or uneven floor coverings when moving the appliance. Some cushioned vinyl floor coverings may not be designed to withstand sliding appliances without marking or damage.

This is a type X appliance regarding installation requirements.

Important: Ensure that you route all mains cables well clear of any adjacent heat source.

Clearances

This cooker may be fitted flush to base units. However, for models with side opening doors, we recommend a side clearance of 60mm between the cooker and any side wall to allow the door to be opened fully.

The cooker should not be placed on a base.

No shelf or overhang or cooker hood shall be closer than a minimum of 650mm, but check with cooker hood manufacturer's recommendations.

The cooker must have a side clearance above hob level of 90mm up to a height of 400mm.

Dimensions

All sizes are nominal, and some variation is to be expected. The 'depth' of the cooker, as given below, is to the front of the door and excluding knobs and handles.

Width: 600mm

Depth: 600mm

Height (adjustable): 900 - 915mm

Levelling the cooker

There are four adjustable feet on the base of the cooker. Slacken the locknut with an M8 spanner and turn the feet by hand to adjust the height of the cooker.

INSTALLATION INSTRUCTIONS

Connect to the electricity supply

Warning: This appliance must be earthed.

The appliance must be installed by a competent electrician using a double pole control unit of 32 ampere minimum capacity with 3mm minimum contact separation at all poles.

We recommend that the appliance is connected by a qualified electrician who is a member of the N.I.C.E.I.C. and who will comply with the I.E.E. and local regulation.

1. Access to the mains terminal is gained by opening the terminal block cover at the rear of the appliance (use a small flat-bladed screwdriver).
2. Connection should be made with 6.0mm² flexible twin and earth cable.
3. First strip the wires, then push the cable through the cable clamp in the terminal block cover.
4. Connect the cable to the terminal block and tighten the cable clamp screw (see diagram).
5. Close the terminal box, ensuring that the cover is engaged on the locking tabs.

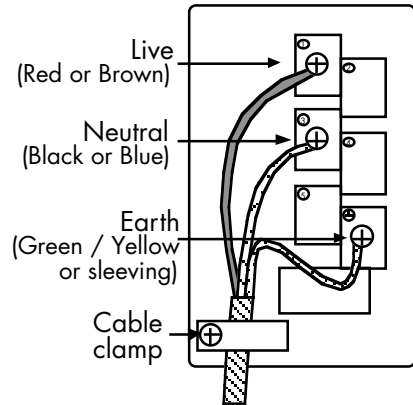

TECHNICAL DATA

Electrical supply

220 - 240V ~ 50Hz

Warning: This appliance must be earthed.

Dimensions

All sizes are nominal so some variation is to be expected.

Databadge is located at the bottom of the front frame, behind the door.

Height (adjustable) 895 - 915mm

Width 600mm

Depth (not including handle) 600mm

Countries of destination

GB - Great Britain, IE - Ireland

Element	Element Ratings (@ 230V)
Front LHS hotplate	ceramic 1100W
Rear LHS hotplate	ceramic 1655W
Rear RHS hotplate	ceramic 1100W
Front RHS hotplate	ceramic 1655W
Dual grill	1655/2575W
Top oven (Base)	700W
Top oven (Top)	590W
Main oven (fanned)	2300W
Oven stir fan	30W
Cooling fan	10W
Lights (x 1)	25W
Maximum Load	10450W

Contact Us

Should you need to get in touch with us (UK and Northern Ireland only), please call Belling Customer Care Centre Helpline on:

0871 22 22 503

For customers outside the UK and Northern Ireland, please contact your local supplier.

When you dial this number you will hear a recorded message and be given a number of options. This indicates that your call has been accepted and is being held in a queue. Calls are answered in strict rotation as our Customer Care Representatives become available.

Enter appliance numbers here for future reference:

Model No							
Serial No							

Please ensure you have the above details (Model No and Serial No) to hand when calling Belling Customer Care. They are essential to booking your call.



Glen Dimplex Home Appliances Limited is the owner of the Belling brand and is part of the Glen Dimplex group of companies.

08 27296 01 © 05.2007
Electric Double Oven
Model Names: E664, E662