

Format

Electric Slot-In Cookers

INSTALLATION AND USER INSTRUCTIONS

Models:- 661 MK 2
630SS
611
612
613
623 MK 2

You must read these instructions prior to using the appliance and retain them for future reference.



Contents

Introduction.....	3
Installing Your Cooker	4
For your own safety - Never	6
- Always	7
Know your Cooker	8
Control Panel.....	9
Timer.....	10-14
Ceramic Hob.....	15
General Information.....	16-17
Choosing Your Utensils	18
Temperature Conversion Scale	19
Grilling.....	20-21
Top Oven Cookery Notes.....	22-23
Top Oven Temperature Charts	24-25
Main Oven Operation.....	26
Main Oven Cookery Notes.....	27-28
Main Oven Temperature Charts	29-30
The Economy Setting.....	31-32
Care and Cleaning	33-36
Is There Something Wrong With Your Cooker?	37
Cooking Results Not Satisfactory?.....	38
Service.....	B/C

This appliance conforms to the following EEC Directives:

Low Voltage Equipment
73/23/EEC
93/68/EEC

Electromagnetic Compatibility
89/336/EEC
92/31/EEC
93/68/EEC



Introduction

Your Belling Cooker

Thank you for purchasing a new Belling Format Cooker. Its stylish and practical design will enhance your kitchen and make cooking a pleasure. It features a fan oven with a separate grill/top oven and a ceramic hob. There is also a clock/timer with a minute minder and automatic oven switch on and off.

Even if you have used an electric cooker before, it is important that you read these instructions thoroughly before starting to cook, paying particular attention to the installation and safety instructions.

Getting Help

If you have any problems with installing, operating, or cooking with your Belling Cooker, please check through these instructions thoroughly to make sure that you have not missed anything. If you still need help, then please contact (including a daytime telephone number if possible):

Belling helpline.
Tel: 01709 579902

Belling Appliances Ltd.
Talbot Road
Mexborough
South Yorkshire
S64 8AJ

If your query relates to cooking then please write to the Senior Home Economist at the same address.

Please quote the cooker model and serial number with all enquiries. This can be found on the rating plate on the oven frame.

WARNING! For your own safety, make sure that these instructions on installation, use and maintenance are followed.

We advise you to keep these instructions in a safe place for future reference.

If you sell or transfer ownership of this product, please pass on these instructions to the new owner.

Installing your cooker

Unpacking

After unpacking your cooker, make sure that you remove all the packing from the oven and grill, and any stickers from the oven door and the hob.

Examine your cooker for any damage, particularly the hob glass. Make sure there are no chips or cracks.

If there is any damage to your cooker or anything is missing, please contact your supplier for advice. If the hob is cracked the cooker must not be connected to the supply, and no part of it may be used.

Siting/Moving the Cooker

Your cooker is heavy, so be careful when moving or positioning it. Do not try to move the cooker by pulling on the doors or handles. The Belling Format is designed to fit between 600mm deep cabinets, spaced a minimum of 600mm apart. It can also be used freestanding, with a cabinet to one side, in an angled corner setting or with its back to a wall.

Never mount the cooker onto a platform.

The cooker is a type X appliance, as such, adjacent side walls which project above hob level must not be nearer to the cooker than 150mm (6") Any overhanging surface or cooker hood should be at least 650mm (25¹/₂") above the cooker hob. We do not recommend positioning the cooker below wall cupboards, as the heat and steam from the cooker may cause damage to the cupboard and its contents.

Whatever the position, remember to leave enough room for the cooker to be pulled out for cleaning and service.

Movement of your cooker is most easily achieved by lifting the front as follows. Open the Grill/Oven door sufficiently to allow a comfortable grip on the underside front edge of the oven roof, avoiding any grill elements or oven interior furniture. Also taking care not to damage floor coverings.

Levelling

Two rear wheels and two front feet are fitted which can be adjusted up or down to set the height (900mm - 915mm) and level the cooker.

1. The rear wheels can be raised or lowered from the BACK of the cooker by adjusting the levelling screws 'A' in the plinth.
2. The front feet can be simply screwed in or out to lower or raise the front of the cooker.

CAUTION: Some soft floor coverings may get damaged if the cooker is not moved carefully.

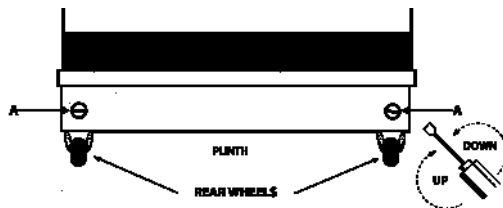

VIEWED FROM REAR

Installing your cooker

Connecting the Cooker

WARNING! THIS APPLIANCE MUST BE EARTHED!

Your cooker should have been checked to ensure that the voltage corresponds with the supply voltage, this is stated on the rating plate, which is situated adjacent to bottom left hand main oven door hinge. The cooker must be connected by a qualified electrician to a suitable double-pole control unit with a minimum of 45A and a minimum contact clearance of 3mm, which should be fitted adjacent to (but not above) the cooker, in accordance with IEE regulations. The power supply cable should conform to BS6004. We recommend P.V.C. insulated twin and earth cable with a conductor size of 6mm². The maximum size of cable that can be used is 10mm².

The control unit should be easily accessible in the event of an emergency.

This appliance conforms to EN55014 regarding suppression of radio and television interference.

Important

For access to the mains terminal block, for supply cable connection, it is necessary to remove the mains terminal cover, located at the lower right-hand side of the rear panel. Pass the cable through the cable clamp and connect to the appropriate terminals provided. Tighten the screws on the cable clamp and replace the cover.

No part of the appliance will operate unless the main control unit is switched **ON**.

Allow sufficient cable length for the cooker to be pulled out for cleaning, but do not let it hang closer than 50mm (2") to the floor. The cable can be looped if necessary, but make sure that it is not kinked or trapped when the cooker is in position.

Before Cooking

Before you cook for the first time, we recommend that you switch on each element in turn to burn off any odours remaining from manufacture. Simply operate each hob element and the grill on maximum for a few minutes, and the oven for approximately 30 minutes. Ensure that the room is well ventilated (eg. open a window or use an extractor fan) and that persons who may be sensitive to the odour avoid any fumes. It is suggested that any pets be removed from the room until the smell has ceased.

Also, before you use the ceramic hob for the first time, clean the hob surface with Belling Ceramic Hob Cleaner and Conditioner. This applies a thin protective film to the hob, making it easier to clean, and prolonging its life.

For your safety

When used properly your Belling Format is completely safe, but as with any electrical appliance there are some precautions you must take in its use.

Never..

- Never stare at Halogen Heating Units.
- Never allow anyone except an authorised Belling Service Agent to service or repair your cooker.
- Never remove any part of the cooker other than those intended in normal use, or attempt to modify the cooker in any way.
- Never use the cooker for commercial catering. It is designed for domestic use and for cooking food only.
- Never allow young children to operate or play with the cooker.
- Never use a chip pan or deep fat fryer more than $\frac{1}{3}$ full of oil, or use a lid while frying, and do not leave a fryer unattended while cooking.
- Never operate the grill with the grill/top oven door closed. This may cause overheating of your cooker.
- Never line the shelves, floor, or sides of the oven or grill, with aluminium foil as overheating and damage may result.
- Never place materials which might catch fire, such as tea towels on the hob or elements, even when the cooker is not in use.
- Never allow aluminium foil or plastic to touch any hob element when it is hot.
- Never use an asbestos mat, trivet or rack of any kind under pans on the hob.
- Never store anything which might catch fire in the oven or grill.
- Never heat unopened containers.
- Never place flammable or plastic items on or near the hob.
- Never dry clothes on either hob or oven doors.
- Never store flammable liquids, aerosols, etc. in adjacent cabinetry.
- Never operate the grill when the ovens are set to cook automatically.
- Never allow any one to sit or stand on any part of the appliance.
- Never use 'steam cleaners'.

For your safety

Always..

- Always take care when touching any part of the cooker which may be hot. Use dry, good quality oven gloves when removing or replacing food or dishes.
- Always stand back when opening the oven door to allow any build-up of heat or steam to disperse.
- Always keep the oven and grill doors closed when not in use to prevent accidents, but remember that the grill door must be kept open when grilling to prevent overheating.
- Always make sure that the roof, side and back panels, and shelves are fitted correctly before using the oven or grill.
- Always keep your cooker clean, as a build-up of grease or fat from cooking may be a fire hazard.
- Always switch off at the mains supply before cleaning your cooker.
- Always supervise children and pets, particularly when grilling, as exposed parts of the grill may become hot.
- Always use suitable pans for the hob, and make sure that they are stable.
- Always keep handles away from the edge of the hob and any heat. For added safety you should consider using a suitable hob guard.
- Always make sure that all the controls are switched off when you finish cooking.
- Always remember that your cooker may stay hot for a time even after you have finished cooking.
- Always keep ventilation slots clear of obstructions.
- Always keep children away from cooker when cleaning at maximum oven setting.
- Always take care when removing stored utensils from the top oven when the main oven is in use as the contents may be hot.
- During use the oven becomes hot. Care should be taken to avoid touching heating elements inside the oven and grill.

Know Your Cooker

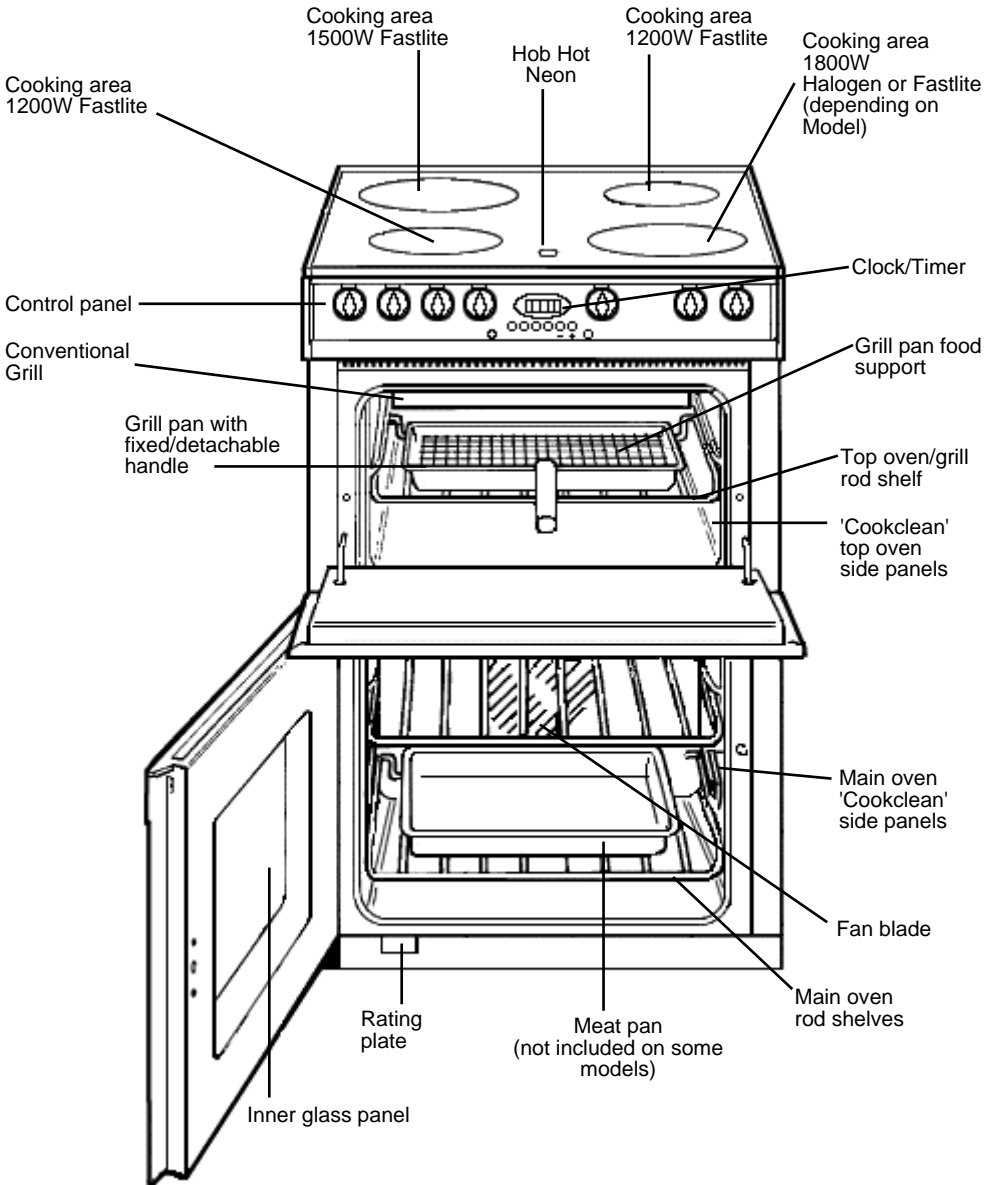

Control Panel

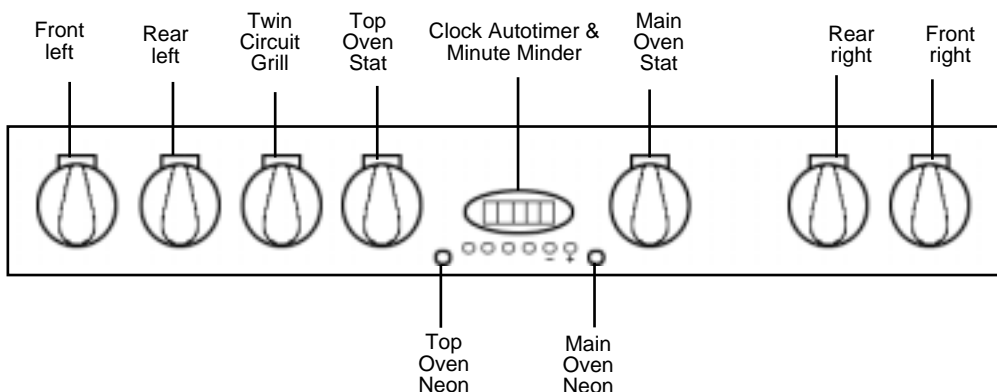

Control knobs

The control knobs have been designed to be easy grip.

The control knobs for the hob elements and grill can be operated in a clockwise or anti-clockwise direction. The control knobs for both ovens can only be turned in a clockwise direction from the off position.

Note: Before retiring for the evening, it is advisable to check that all cooker controls have been switched **Off** and that nothing is left on the hob.

Operating controls when the grill is in use

In common with all cookers having controls sited above the grill compartment, care must be taken when setting the controls, due to the hot air expelled from the grill compartment.

Cooling fan

To keep the controls cool when the appliance is used, a gentle flow of air may be blown from beneath the control panel. If the appliance is still warm, this cooling fan may run on or restart itself when all controls have been turned off.

This is normal and is not a fault.

The fan will stop once the appliance has cooled.

Main oven light

The oven light will illuminate when the oven control is operated. The light will remain on during the cooking period. (NB. some Models have no oven light).

Economy Setting

The main oven has a Slow Cook setting specially designed to reduce energy usage.

To operate turn main oven thermostat to 90°C.

Oven Timer Operation

The oven timer offers you the following features:

1. Time of Day
2. Automatic Cooking
3. Minute Minder

The automatic timer can control the Main oven only. When the timer control has been set for the main oven it is possible to use the other oven on non automatic cooking.

Never operate the grill when the Oven is set to cook automatically.

Hints on Automatic Cooking

1. Select foods which will take the same time to cook and require approximately the same temperature.
2. Set the oven timer so that the food has just finished or about to finish cooking on your return to the oven. This will ensure the food has not cooled down and does not require reheating before serving.
3. Food should be as cold as possible when it goes into the oven, ideally straight from the refrigerator. Frozen meat and poultry should be thawed thoroughly before it is put in the oven.
4. We advise that warm food should never be placed in the oven if there is to be a delay period. Stews prepared by frying the meat and vegetables should be cooked as soon as possible.
5. We advise dishes containing left-over cooked poultry or meat, for example Shepherds Pie, should not be cooked automatically if there is to be a delay period.
6. Stews and joints should be cooked by the long slow method, so that the delay period is kept to a minimum.
7. On warm days, to prevent harmful bacterial growth in certain foods (ie poultry, joints, etc) the delay start should be kept to a minimum.
8. Wine or beer may ferment and cream may curdle during the delay period, so it is best to add these ingredients just before serving.
9. Foods which discolour should be protected by coating in fat or tossing in water to which lemon juice has been added, prior to placing food in the oven.
10. Dishes containing liquid should not be filled too full to prevent boiling over.
11. Foods should be well sealed (but not airtight) in a container to prevent the loss of liquid during cooling. Aluminium foil gives a good seal.
12. Ensure food is cooked thoroughly before serving.

Oven Timer Operation

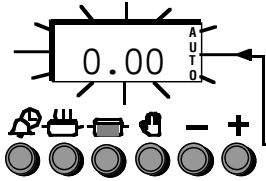

TO SET TIME OF DAY

- Step 1** Make sure all oven controls are turned off.
- Step 2** Check the electricity supply to the cooker is turned on.
- Step 3** When switched on the display will show **0.00** and **AUTO** symbol will be flashing intermittently.
- Step 4** Press and hold the “🕒” Minute Minder & “🍳” Cook Period button together.
- Step 5** With the “🕒” Minute Minder & “🍳” Cook Period buttons still held in, press either the “+” or “-” buttons to set the correct time of day.
- Step 6** Release all the buttons simultaneously.

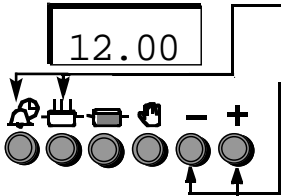

THE TIME OF DAY IS NOW SET.

To change the time of day repeat steps 4,5 & 6 above.

Note: You cannot adjust the time of day if the timer has been set for an Auto Cooking Programme.

To Set Timer To Switch OFF Automatically

This allows you to cook immediately for a chosen period before the oven switches Off Automatically

- Step 1** Ensure the time of day is set correctly.
- Step 2** Place food onto the correct shelf position in the oven.
- Step 3** Turn the oven control to the required temperature (Oven should now be operating).

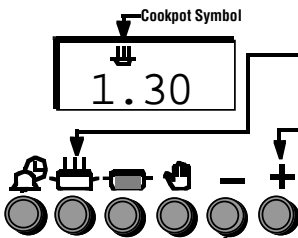

Step 4

Press and release the “🍳” button the display will read 0.00 with the cookpot lit.

Within 2 seconds press and hold the “+” button until the required cooking period is set.

(Adjustment can be made by pressing the “-” button).

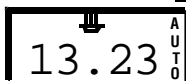

The timer display will revert to the time of day with the Auto symbol and Cookpot lit.

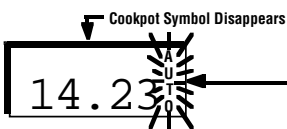

At the end of the cooking period the Auto symbol will Flash and an intermittent bleeping sound will be heard.

– This will continue for approximately 2 minutes unless the timer is reset within this period (See Step 6).

The oven will now no longer operate until the timer has been reset.
(See Steps 5 & 6 on next page)

Oven Timer Operation

To Set Timer To Switch OFF Automatically (cont.)

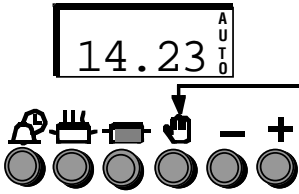

Step 5

Turn off the oven control.

Step 6

Press the “🔔” button to cancel the bleeping. (If 2 minutes has not elapsed.)

Press “🔔” button again to return to Manual Operation.

To Set Timer To Switch ON and OFF Automatically

This allows you to cook at a specified time for a chosen period before the oven switches Off Automatically.

Step 1 Ensure the time of day is set correctly.

Step 2 Place food onto the correct shelf position in the oven.

Step 3

Press and release the “🔥” button the display will read 0.00 with the cookpot lit.

Within 2 seconds press and hold the “+” button until the required cooking period is set.

(Adjustment can be made by pressing the “-” button).

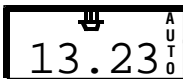
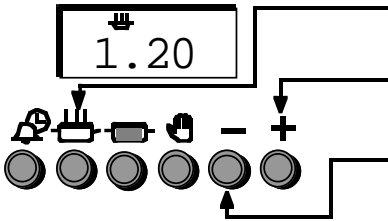

The timer display will revert to the time of day with the Auto symbol and Cookpot lit.

Step 4

Press the release the “🔥” button the display will read the earliest possible end time with the Cookpot and Auto symbol lit.

Within 2 seconds press and hold the “+” button to set to the time you require the food to be ready, with only the Auto symbol lit.

(Adjustment can be made by pressing the “-” button).

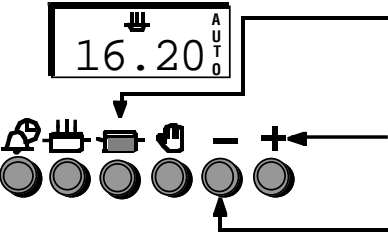

Step 5

Turn the oven control to the required temperature.

The oven will now switch on later in the day for the cooking period required and will cut off automatically at the stop time setting.

At the end of the cooking period the Auto symbol will flash and an intermittent bleeping sound will be heard.

This will continue for approximately 2 minutes unless the timer is reset within the period. (See Step 7 on next page).

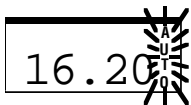

Oven Timer Operation

To Set Timer To Switch ON and OFF Automatically (*cont.*)

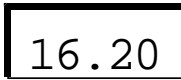

16.20

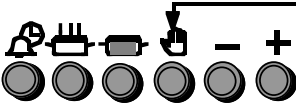



The oven will no longer operate until the timer has been reset to manual operation.

Step 6









Turn off the oven control.

Step 7

Press the “” button to cancel the bleeping sound. (If 2 minutes has not elapsed.)

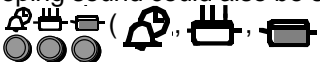
Press “” button again to return oven to “Manual Operation”.

Other Notes On Timer Operation

1. When cooking Automatically the cook period can be checked at any time simply by pressing the “” button.
2. When cooking Automatically the Stop time can be checked at any time by simply pressing the “” button. (This also can be altered at any time by following step 4 above.)
3. Having set a cooking period and Stop time an electronic device stores the information. The device within the timer will switch the oven on at the required start time.
4. If a mistake is made and is not readily rectified alter the cook period to show  (as per Step 3 above) then press the “” (see Step 7 above) and start the sequence again.
5. After an Automatic sequence the bleeping sound could also be switched off by pressing any of the three buttons  (, , ).

However the cooker cannot be re-used until the timer has been set to manual operation, this is achieved by pressing the “” button (see Step 7 above).

6. If at any time the display shows three flashing zero's 0.00 . It is likely that the electricity supply to the oven has been interrupted. Reset the timer to the correct time of day. *Food in the oven may therefore not have been cooked, before serving check food is thoroughly cooked.*
7. To give yourself more time to set each function press and hold the required function button and at the same time press “+” or “-” button.

NOTE: Between the hours of 10.00p.m. and 6.00a.m. the intensity of the display reduces.

Oven Timer Operation

To Set The Minute Minder

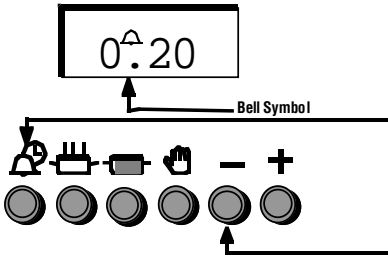

Step 1

Ensure the time of day is set correctly.

Step 2

Press and release the “” Button. Within 5 seconds press and hold the “+” button until the required time is set, a “Bell” symbol will light up.

This can be adjusted by pressing the “-” button.

The timer will then revert back to the time of day.

At the end of the set time a bleeping sound will be heard and the “Bell” symbol will flash.

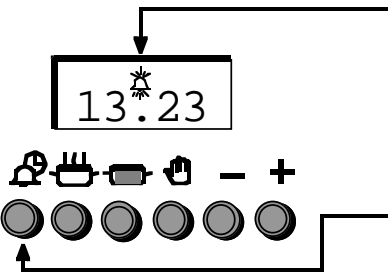

This can be cancelled by pressing the “” button.

NOTE: If necessary the Minute Minder can be cancelled before the tone sounds by pressing the “” button and then pressing the “-” button until 0.00 appears in the display window.

Ceramic Hob

Ceramic hob

WARNING! If any crack should appear on the hob, isolate the cooker immediately from the mains supply. Never use any part of the cooker but contact your Belling Service Agent.

Under no circumstances should the hob be used with aluminium foil in contact with the hob surface, as damage will occur.

The following boiling plates are located beneath the decorative circular patterned cooking areas:

Front Left	1.2kW Fastlite
Rear Left	1.5kW Fastlite
Rear Right	1.2kW Fastlite
Front Right	1.8kW Fastlite or Hologen

The cooking areas change colour when heated (become red) indicating which heating element is energised. The cooking area returns to its original colour when the heating element is switched off and cools.

Halogen Elements

Halogen elements use a lamp and an inner heating coil together. As the halogen lamp is very bright when lit, the inner coil may appear duller (i.e. not working); this is normal and the element is working properly.

Warning

Even though the cooking area has returned to its original colour it may still be hot.

Hob Hot Light

This will operate soon after any of the four boiling plate controls are turned on, and will remain illuminated until the ceramic surface has cooled.

Controls

Fastlite hotplates:- The controls set the hotplates at six pre-set power indicator levels indicated by the numbered markings. (1 is the minimum and 6 is the maximum setting)

Halogen hotplates:- The control provides fully variable heat control selecting any number or intermediate settings between 1 (minimum) and 6 (maximum). The hotplate will be off at the 'O' position.

To reduce the heat to cook more slowly or simmer, turn the knob to a lower setting which will vary according to size and type of saucepan, the amount and type of food, and whether or not a lid is fitted. Pans can be placed on the unheated areas of the panel when cooking is finished and before serving food. It is inadvisable at any time to leave a heating element switched on without a pan in position as this wastes energy, and could make soil or rub-off from aluminium pans more difficult to remove. To protect elements against over-heating, safety cut-outs have been incorporated with each element. After several minutes with the control at setting 6 the safety cut-out switches the element **Off** and **On** continuously, thus preventing any adverse effects that may be caused by an excessive build-up of heat in the cooking area.

General Information Notes

(Ceramic Hobs)

Never

- Never** Stare at Halogen heating units.
- Never** Cook directly on the hob surface without a cooking utensil as this will result in damage to the surface of the hob.
- Never** use the hob as a worktop surface as damage may occur to the smooth surface of the hob.
- Never** drag or slide utensils on the hob surface, as this will cause scratches in the surface of the hob.
- Never** allow a cooking utensil to come into contact with the hob surround.
- Never** place anything between the base of the utensil and the ceramic hob, eg do not use asbestos mats, aluminium or wok stands.



- Never** leave any utensils, food or combustible items on the hob when it is not in use.
- Never** place aluminium or plastic foil, or plastic containers on the hob.
- Never** leave the hotplates or cooking areas switched **On** unless they are being used.

We recommend not to place large preserving pans or fish kettles across two heating areas.

- Never** leave utensils partly covering the heated areas. Always ensure that they are placed centrally over the heated areas and have the same diameter as the heating area used.



We recommend not to use a utensil with a base diameter greater than 25cm (10ins).

If hob should become cracked, **Never use until repaired.**

Always

- Always** ensure that saucepan handles are positioned safely.
- Always** use good quality smooth flat based utensils.
- Always** use a utensil which has approximately the same base area as the heating area zone being used.
- Always** use utensils which have more than sufficient capacity for the amount of food being cooked to prevent boil over or spillage.
- Always** use utensils with good fitting lids.
- Always** use a low dome pressure cooker for best results.

General Information Notes

(Ceramic Hob)

IMPORTANT - As with any cooking appliance there could be some fire risk attached to the heating of oil, particularly for deep fat frying, cooking utensils containing oil **must not be left unattended** (eg to answer the telephone) on or in close proximity to the patterned cooking areas.

In the unfortunate event of a chip pan fire:

1. TURN OFF THE COOKING APPLIANCE AT THE WALL SWITCH.
2. COVER THE PAN WITH A FIRE BLANKET OR DAMP CLOTH, this will smother the flames and extinguish the fire.
3. LEAVE THE PAN TO COOL FOR AT LEAST 60 MINUTES BEFORE MOVING IT. Picking up a hot pan and rushing outside with it often causes injuries.

NEVER USE A FIRE EXTINGUISHER TO PUT OUT A PAN FIRE as the force of the extinguisher is likely to tip the pan over. Never use water to extinguish oil or fat fires.

Safety requirements for deep fat frying

1. Use a deep pan, large enough to completely cover the appropriate heating area.
2. Never fill the pan more than one-third full of fat or oil.
3. Never leave oil or fat unattended during the heating or cooking period.
4. Do not try to fry too much food at a time, especially frozen food. This only lowers the temperature of the oil or fat too much, resulting in greasy food.
5. Always dry food thoroughly before frying, and lower it slowly into the hot oil or fat. Frozen foods, in particular, will cause frothing and spitting, if added to quickly.
6. Never heat fat, or fry, with a lid on the pan.
7. Keep the outside of the pan clean and free from streaks of oil or fat.

Choosing your utensils

Below are some guidelines to help you make the right choice of utensils.

To obtain a satisfactory performance from a ceramic hob and to avoid unnecessary damage, we recommend the use of good quality utensils with smooth flat bases.

Remember

1. Purchasing a new pan will not necessarily mean it will have a flat base, always check before buying. See diagram below.
2. Using the correct pans and utensils will result in maximum contact with the hob and maximum efficiency as with any type of electric hob.



Good quality flat base same size as element



Convex base too small



Concave base



Too small



Too large



No Pan Element ON

Choosing Your Utensils

Important

WARNING: Extreme caution should be taken to avoid steam burns and hot surfaces when cleaning up spillage to the hot hob.

1. Always clean up any spillage immediately with a clean cloth or a paper towel to avoid unnecessary damage to the hob.
2. When cooking food which contains sugar (most food) or syrup, use a utensil which is large enough to prevent boil over or spillage. **Sugar spillage will permanently damage the hob and therefore should be cleaned off with care immediately.** If sugar spillage has occurred, remove it as long as it is still hot with a metal handled razor-blade scraper, commercially available. This will avoid any damage. **NEVER LET IT COOL BEFORE REMOVING.**
3. Always ensure that the base of the utensil is dry before placing on the ceramic hob.

Never

Never use utensils with rough bases.

Never use lightweight utensils with thin, distorted or uneven bases.

Never use lightweight enamelled steel utensils.

Never use cast iron utensils.

Never use utensils with recessed, scrolled or ridged bases.

Never use a utensil which has a base concavity greater than 1 mm as this will reduce the performance of the hob.

Never use a utensil with a convex base.

Never use glass ceramic utensils.

Never use lightweight saucepans with plain thin copper bases on ceramic or halogen hotplates.

Note: All copper pans are excellent conductors of heat, and are hard wearing and strong, but need quite a lot of care. They can be very heavy and do not usually have completely flat bases. The interiors are usually lined with a different material such as tin.

A stainless steel pan with a sandwich base of aluminium and stainless steel is an excellent conductor of heat and is suitable for use on ceramic and halogen hobs, providing they are used in accordance with the saucepans manufacturers' recommendations.

Stainless steel pans with a sandwich base of aluminium and copper are excellent conductors of heat. If using stainless steel saucepans with aluminium and copper sandwich bases on ceramic and halogen hobs, the use of these pans must be in accordance with the saucepan manufacturers' recommendations. Extra care should be taken to ensure the base of the pan and the hob is cleaned, and the hob conditioned, after each and every use, when using this type of saucepan.

If these recommendations are not followed, the result will be a build up of small copper deposits on the surface of your hob, which, if not cleaned after each use, will result in permanent marking of your hob.

Always lift the pan from the hob, **Never** drag or slide across the hob surface as damage may occur.

Approximate Oven Temperature

Conversion Chart

Gas Mark	Conventional Oven		Fan Oven (It is not always necessary to preheat oven)
	°F	°C	°C
1/2	250	120	100
1	275	140	120
2	300	150	130
3	325	160	140
4	350	180	160
5	375	190	170
6	400	200	180
7	425	220	200
8	450	230	210
9	475	240	220

Grilling

Grill Pan Handle

The grill pan handle is detachable from the pan, to facilitate cleaning and storage. The handle can be either detachable from or fixed to the pan. For a fixed handle remove the screw and washers from the grill pan bracket, tilt the handle over the recess adjacent to the bracket (1), slide it towards the centre of the pan (2) and let the handle locate over the bracket (3). Replace screw and washers and ensure that they are fully tightened up. For a detachable handle remove screw and washers from the grill pan and keep in a safe place.

Please note, if a fixed handle is required, grill pan is unable to be kept in the Fan Oven with door closed, but may be stored in the Top Oven with door closed.

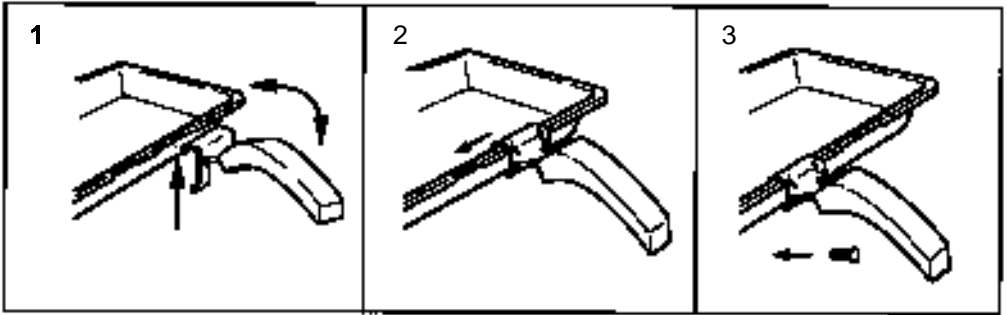

Door position
for Grilling.

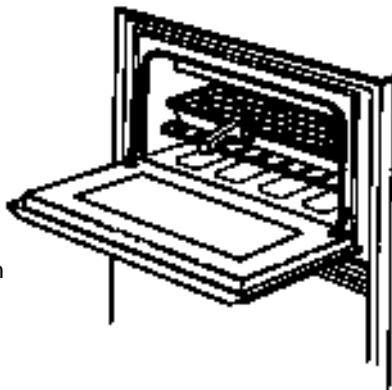

Fig 5

Grilling

NEVER allow young children near the appliance when the grill is in use as the surfaces get extremely hot.

GRILLING SHOULD NEVER BE UNDERTAKEN WITH THE GRILL/ TOP OVEN DOOR CLOSED. (See Fig.5).

DO NOT LINE THE GRILL PAN WITH ALUMINIUM FOIL.

The grill control is designed to provide variable heat control of either left and right grill elements on together or the left hand only, depending upon which direction the control knob is rotated. With the control knob rotated clockwise both elements will come on together, and with the control rotated anti-clockwise only the left hand element will come on. **Do not** operate the Top Oven control when grilling.

Preheat the grill at **4** setting for approximately 5 minutes.

When toasting/grilling, the rod shelf is placed in either the second or third runner from the bottom. The grill pan is placed centrally on the shelf and pushed back until it locates in the stop on the shelf. This will correctly position the pan under the grill element. Leave the control at **4** for toast, and for sealing and fast cooking of foods. For thicker foods requiring longer cooking, turn the switch to a lower setting after the initial sealing on both sides at **4**. The thicker the food, the lower the control should be set.

Use anti-splash tray in grill pan (not available on some models).

Food which requires browning only should be placed under the hot grill on the second or third runner from the bottom of the oven, according to the depth of the dish.

After use, always return controls to their off position.

Top Oven Cookery Notes

The charts on pages 24 and 25 are a guide only, giving approximate cooking temperatures and times. To suit personal taste and requirements, it may be necessary to increase or decrease temperatures by 10°C.

The Top Oven is fitted with 'Cookclean' sides and one rod shelf. It is heated by two elements - the grill element and an element under the floor of the oven - and has a fully variable temperature control like the main oven. To heat the oven, turn the control knob clockwise, selecting the required temperature between 100°C (200°F) and 220°C (425°F) as recommended in the Top Oven temperature chart. The pilot light will immediately come on and remain on until the oven reaches the required temperature. The light will then automatically go off and on during cooking as the oven thermostat maintains the correct temperature.

Top Oven for cooking

The Top Oven is used in exactly the same way as the Main Oven to cook all types of food. It can either be used alone, to cook small quantities of food, or in conjunction with the Main Oven to provide additional cooking space, so often necessary when entertaining. There are two cooking positions - runners 1 and 2 from the bottom of the oven. The correct positioning of food is indicated in the temperature charts on pages 24 and 25. These charts are a guide only, giving approximate cooking temperatures and times. To suit personal taste and requirements, it may be necessary to increase or decrease temperatures by 10°C. Food should be positioned centrally under the grill element (As a guide the front of the utensil should be approximately 100mm (4ins.) from the front of the shelf.) Food must never be placed directly on the floor of the oven, and there should always be at least 25mm (1in.) between the top of the food and the grill element. **NEVER** use utensils larger than 300mm (12ins.) x 230mm (9ins.). Larger utensils should be used in the Main Oven.

Cooking Meat/Poultry in the Top Oven

The Top Oven is most useful for the longer slower cooking required for cheaper cuts of meat - casserole cooking, pot roasting, braising etc.

Small joints of meat up to 1.5kg (3 lbs) or poultry up to 3.6kg (8 lbs) in weight can be roasted in a small meat pan in the Top Oven, but should preferably be 'slow roasted' or covered with a lid of aluminium foil (one or two incisions in the top of the foil will allow the meat or poultry to brown). Always ensure that there is at least 25mm (1in.) between the top of the foil and the grill element. Do not use the grill pan as a meat pan. Larger joints of meat weighing more than 1.5kg (3 lbs) or poultry weighing more than 3.6kg (8 lbs) should be roasted in the Main Oven.

Do not use large main oven meat pans in top oven.

Never line the shelves, floor or sides of the oven or grill with aluminium foil as overheating and damage may result.

Top Oven Cookery Notes

Top Oven as a Hotcupboard

Plates and dishes placed on the floor of the Top Oven will be heated when the Main Oven is in use. When the Main Oven is not in use (for instance when a meal is being cooked on the hob) place the plates and serving dishes on the rod shelf using the bottom runner and turn the Top Oven control to approximately 100°C (200°F). A maximum time of 10-12 minutes is all that is required to heat the plates and dishes.

NEVER operate the grill control when using the Top Oven for cooking or as a hotcupboard.

Note: Utensils stored in top oven will get hot when main oven is in use. Care should be taken when removing them.

Top Oven Temperature Chart

Top Oven Cooking				
Meat	Pre-heat	Temperature °C	Time (approx.)	Position in Oven
Beef/ Lamb (slow roasting)	Yes	170/180	35 mins per 450g (1 lb) + 35 mins over.	Runner 1 from bottom of oven.
Beef/ Lamb (foil covered)	Yes	190/200	35-40 mins per 450g (1 lb)	
Pork (slow roasting)	Yes	170/180	40 mins per 450g (1 lb) + 40 mins over	
Pork (foil covered)	Yes	190/200	40 mins per 450g (1 lb)	
Veal (slow roasting)	Yes	170/180	40-45 mins per 450g (1 lb) + 40 mins over	
Veal (foil covered)	Yes	190/200	40-45 mins per 450g (1 lb)	
Poultry/Game (slow roasting)	Yes	170/180	25-30 mins per 450g (1 lb) + 25 mins over	
Poultry/Game (foil covered)	Yes	190/200	25-30 mins per 450g (1 lb)	
Casserole Cooking	Yes	150	2-2½ hrs	

If using aluminium foil:

1. Remember it is important to increase the cooking time by one third;
2. Never allow foil to touch sides of oven;
3. Never cover oven interior with foil;
4. Never cover oven shelves with foil.

The most accurate method of testing the readiness of joints of meat or whole poultry is to insert a meat thermometer into the thickest part of a joint, or the thickest part of poultry thighs, during the cooking period. The meat thermometer will indicate when the required internal temp has been reached.

Beef -	Rare:	60°C	Lamb:	80°C	Poultry:	90°C
	Medium:	70°C	Pork:	90°C		
	Well Done:	75°C	Veal:	75°C		

Top Oven Temperature Chart

Baking	Top Oven Cooking			
Food	Pre-heat	Temperature °C	Time in mins.	Position in Oven
Scones	Yes	210/220	10-15	Runner 1 from bottom of oven.
Small Cakes	Yes	180/190	20-25	Runner 1 from bottom of oven.
Victoria Sandwich	Yes	170/180	20-30	Runner 1 from bottom of oven.
Sponge Sandwich (fatless)	Yes	180/190	20-25	Runner 1 from bottom of oven.
Swiss Roll	Yes	200/210	10-15	Runner 1 from bottom of oven.
Semi-rich Fruit cakes	Yes	150/160	60-75 7 inch	Runner 1 from bottom of oven.
Rich Fruit Cakes	Yes	130/140	Time Dependent on size	Runner 1 from bottom of oven.
Shortcrust Pastry	Yes	190/200	Time Dependent on recipe	Runner 1 from bottom of oven.
Puff Pastry	Yes	200/210	Time Dependent on recipe	Runner 1 from bottom of oven.
Yorkshire Pudding	Yes	190/200	30-40	Runner 2 from bottom of oven.
Individual Yorkshire Puddings	Yes	200/210	20-30	Runner 2 from bottom of oven.
Milk Pudding	Yes	130/140	90-120	Runner 1 from bottom of oven.
Baked Custard	Yes	140/150	40-50	Runner 1 from bottom of oven.
Bread	Yes	200/210	30-45	Runner 1 from bottom of oven.
Meringues	Yes	100	150-180	Runner 1 from bottom of oven.

Note: If soft tub margarine is used for cake making, we would recommend using the all in one method and to reduce the temperature by 10°C. Temperatures recommended in this chart refer to cakes made with block margarine or butter only.

Main Oven

Oven Thermostat Turn the main oven thermostat to set the required temperature, the oven light will come on. (Not applicable to some Models).

When operated an indicator light will immediately come **On**, and will go out when the desired temperature is reached, subsequently switching **On** and **Off** at intervals to indicate that the correct temperature is being maintained. The fan will operate continuously whilst the oven is switched **On**.

Note: If the indicator light does not come **On** when the control is turned, check that the timer is in **Manual** operation.

Main Oven Cookery Notes

Since a fan oven heats up more quickly, and generally cooks food at a lower temperature than a conventional oven, pre-heating the oven is often unnecessary. However, foods such as bread, scones, Yorkshire pudding, do benefit from being placed in a pre-heated oven.

The charts on pages 29 and 30 are a guide only, giving approximate cooking temperatures and times. To suit personal taste and requirements, it may be necessary to increase or decrease temperatures by 10°C.

Because the fan oven cooks so efficiently, we recommend that when cooking any recipes not designed for a fan oven, you reduce the temperature by about 25°C and the time by about 10 minutes in the hour. If large quantities are being cooked it will be necessary to increase the cooking time somewhat to compensate for the extra oven load.

Unless otherwise indicated in the charts, food is placed in a cold oven, i.e. without pre-heating. If food is placed in an already hot oven, the suggested cooking time should be reduced, depending on the type and quantity of food being cooked.

It should be noted that at the end of a cooking period there may be a momentary puff of steam when the oven door is opened, this will disperse in a few seconds and is a perfectly normal characteristic of an oven with a good door seal.

Oven Positions

Since the distribution of heat in the fan oven is very even, most foods will cook satisfactorily on any shelf position, but the shelves should be evenly spaced:

To ensure even circulation do not use meat pans larger than 390 x 300mm (15ins x 12ins) and baking trays no larger than 330 x 255mm (13ins x 10ins), these should be positioned centrally on the oven shelf.

- Do not fit shelves upside down.
- Never use more than 3 shelves in the oven as air circulation will be restricted.
- Food or cooking utensils should not be placed on the floor of the oven.

To avoid unnecessary cleaning, rod shelves which are not in use should be removed from the oven.

Never line the shelves, floor or sides of the oven or grill with aluminium foil as overheating and damage may result.

Main Oven Cookery Notes

Temperature and Time

When all three shelves (the Top oven shelf can be used in the Main oven) are used to cook large quantities of food for home freezing or parties, it may be necessary to increase the cooking times given in the charts on pages 29 and 30 by a few minutes, to allow for the loss of heat due to the extra time taken to load the oven, and the larger mass of food. Baking trays should allow an equal gap on all sides of the oven.

To prepare Meat and Poultry for Roasting in your Fan Oven

- (a) Wipe the meat or poultry, dry well and weigh it. Meat which has been stored in a refrigerator should be allowed to come to room temperature before cooking. Frozen meat or poultry must be completely defrosted before placing in the oven.
- (b) The weight of any stuffing used should be added before calculating the cooking time.
- (c) Place meat/poultry in a meat pan. Small joints weighing less than 1.75kg (3 1/2 lbs) should be roasted in a smaller meat pan/tin – or they may be 'pot roasted' – a small joint or a large meat pan causes unnecessary oven splashing and evaporation of meat juices.
- (d) Additional fat should not be added, except for veal, very lean meat or poultry which can either be 'larded' with fat bacon or brushed **very sparingly** with cooking oil or melted fat.
- (e) Beef, lamb, mutton and poultry may be dusted lightly with seasoned flour to give a crisp outer surface. The skin of duck and goose should be pricked to release excess fat during cooking, and the rind of pork should be scored, brushed lightly with oil, and rubbed with salt to give crisp crackling.
- (f) Meat and poultry wrapped in, or covered with a tent of aluminium foil will be juicy and tender. Roasting bags offer the same advantages. Always follow the manufacturer's pack instructions, and remember to reduce the temperatures given for conventional ovens by approximately 25°C and the time by approximately 10 minutes per hour.
- (g) Potatoes for roasting only require to be brushed with cooking oil or melted fat.
- (h) It is not necessary to baste when roasting in an electric oven and stock or liquid should not be added to the meat pan since this only causes unnecessary soiling, steam and condensation.

Frozen Meat and Poultry

Joints of meat and whole birds should be defrosted slowly, preferably in a domestic refrigerator (allowing 5-6 hours per 450g, 1 lb), or at room temperature (allowing 2-3 hours per 450g, 1 lb).

Frozen meat or poultry must be completely defrosted before placing in the oven.

It is essential to wash thoroughly and cook meat and poultry immediately after defrosting.

Main Oven Temperature Chart

Note: Where times are stated, they are approximate only.

Baking	Fan Oven		
	Pre-heat	Temperature °C	Time
Scones	Yes	210/220	9-12 mins. approx.
Small Cakes	No	170/180	15-20 mins. approx.
Victoria Sandwich	No	160/170	20-25 mins. approx.
Sponge Sandwich (Fatless)	Yes	170/190	15-20 mins. approx.
Swiss Roll	Yes	180/200	12-15 mins approx.
Semi-rich Fruit cakes	No	140/150	1¼ - 1½ hrs. approx.
Rich Fruit Cakes	No	130/140	Depending on size.
Shortcrust Pastry	No	190/200	Depending on size.
Puff Pastry	No	190/200	Depending on size
Yorkshire Pudding	Yes	180/190	40-50 mins. approx.
Individual Yorkshire Puddings	Yes	190/200	20-25 mins. approx.
Milk Pudding	No	130/140	1½ - 2 hrs. approx.
Baked Custard	No	140/150	35-45 mins. approx.
Bread	Yes	200/210	30-35 mins. approx.
Meringues	No	70-90	3-4 hrs. approx.

Note: If soft tub margarine is used for cake making, we would recommend using the all in one method and to reduce the temperature by 10°C. Temperatures recommended in this chart refer to cakes made with block margarine or butter only.

Main Oven Temperature Chart

It is not necessary to pre-heat the fan oven before roasting. Note: Where times are stated, they are approximate only.

Fan Oven			
Meat	Pre-heat	Temperature °C	Time (approx.)
Beef	No	160/180	20-25 mins per 450g (1lb) + 20 mins extra
Lamb	No	160/180	20-30 mins per 450g (1lb) + 25 mins extra
Pork	No	160/180	25-30 mins per 450g (1lb) + 25 mins extra
Veal	No	160/170	25-30 mins per 450g (1lb) + 25 mins extra
Chicken/ Turkey up to 4kg (8 lb)	No	160/180	18-20 mins per 450g (1lb) + 20 mins extra
Turkey 4 to 5.5kg (8 to 12 lb)	No	150-160 or 150	12-14 mins per 450g (1lb) at plus 12 mins extra *For every 450g (1lb) over 5.5kg (12lb) allow 10 mins per 450g (1lb), and roast at 150°C
Casserole Stews	No	140-150	1½ - 2 Hrs
<p>If using aluminium foil, never:</p> <ol style="list-style-type: none"> 1. Allow foil to touch sides of oven. 2. Cover oven interior with foil. 3. Cover shelves with foil. 			

The most accurate method of testing the readiness of joints of meat or whole poultry is to insert a meat thermometer into the thickest part of a joint, or the thickest part of poultry thighs, during the cooking period. The meat thermometer will indicate when the required internal temp has been reached.

Beef -	Rare:	60°C	Lamb:	80°C
	Medium:	70°C	Pork:	90°C
	Well Done:	75°C	Veal:	75°C
			Poultry:	90°C

The Economy Setting

Economy Setting

The main oven has an Economy setting specially designed to reduce energy usage.

To operate turn main oven thermostat to 90°C.

This is used for slow cooking, keeping food warm and warming plates for short periods. Extra care must be taken when warming bone china, as it may be damaged in a hot oven.

Some advantages of Economy cooking are:

The oven stays cleaner because there is less splashing.

Timing of food is not as critical, so there is less fear of overcooking.

Inexpensive cuts of meat are tenderised.

Fully loading the oven can be very economical.

Cooking times can be extended in some cases by up to 2hrs. slow cook.

Using the Economy Setting

Points to bear in mind when preparing food:-

1. Make sure all dishes will fit into the oven before preparing the food.
2. All dishes cooked by the 'Economy' setting should be cooked for a minimum of 6 hours. They will 'hold' at this setting for a further hour but marked deterioration in appearance will be noticed in some cases. Egg and fish dishes need only 1-5 hours cooking and should be observed from time to time.
3. Joints of meat and poultry should be cooked at fan oven 170°C for 30 mins before turning to the 'Economy' setting.
4. Meat over 2.7 Kg. (6 lbs) and poultry over 2 Kg. (4 lbs 8oz) are unsuitable for the 'Economy' setting.
5. Always stand covered joints on a rack over the meat tin, to allow good air circulation.
6. Pork joints can only be cooked, if by testing with a meat thermometer, an internal temperature of at least 88°C is reached.
7. This method is unsuitable for stuffed meat and poultry.
8. Always bring soups, casseroles and liquids to the boil before putting in the oven.
9. When casseroles are used, cover the food first with foil and then the lid to prevent loss of moisture.
10. Always thaw frozen food completely before cooking.
11. Root vegetables will cook better if cut into small even sized pieces.
12. Always adjust the seasoning and thickenings at the end of the cooking time.
13. Dried red kidney beans must be boiled for a minimum of ten minutes after soaking, before inclusion in any dish.

Storage and Re-heating of Food

1. If food is to be frozen or not served immediately, cool it in a clean container as quickly as possible.
2. Thaw frozen food completely in the refrigerator before re-heating.
3. Re-heat food thoroughly and quickly either on the hotplate or in the fan oven, 170°C and then serve immediately.
4. Only re-heat food once.

Care and Cleaning

WARNING! never use steam cleaners

In the interests of both safety and hygiene your Belling Format needs to be kept clean. A build-up of grease or fat from cooking could cause a fire hazard.

WARNING! For your own safety, always switch off your cooker at the mains supply and allow to cool before cleaning.

Never use excessive amounts of water to clean your cooker, and remember that your cooker is heavy – take care when pulling it out for access.

Ceramic Hob

WARNING! If any crack should appear on the hob, isolate the cooker from the mains supply. Do not use any part of the cooker but contact your Belling Service Agent.

The ceramic hob is very hard wearing and with normal care should remain in good condition. However, it is important that any spillage is dealt with before the hob is used again, otherwise it will become baked on.

Once the hob has cooled, remove any heavy spillage or soiling with a metal spatula, palette knife or scraper, then use a little Belling Ceramic Hob Cleaner & Conditioner on a damp cloth to remove any marks. Wipe off the residue of the cleaner with a soft damp cloth and polish the hob with a soft lint-free cloth. It is important that the hob is cleaned regularly with Belling Ceramic Hob Cleaner & Conditioner as it provides a protective film to keep the hob in good condition and assists in keeping the hob clean.

Whilst it is recommended that normal cleaning is carried out when the hob has cooled, if jam, fruit or anything with a high sugar content is spilled on the hob, or plastic or aluminium is melted onto the hob, clean it off immediately, as damage to the hob can result. Switch off the hob and use a metal spatula, palette knife or scraper to remove the spillage. **TAKE CARE**, as the spillage and the hob may be very hot. When the hob has cooled, clean as usual with Belling Ceramic Hob Cleaner & Conditioner.

Do not use scouring powders or paste, wire wool scouring pads, or oven cleaners on the hob as these can cause damage to the hob surface. If you require further Belling Ceramic Hob Cleaner & Conditioner please contact Belling Customer Helpline on 01709 579902 or Spares dept. on 01709 579907

Cooker Exterior

The outside surfaces of your cooker should be cleaned with a mild detergent and a little water. Wipe off the detergent with a damp cloth and dry the cooker with a soft lint-free cloth. For stainless steel products, use a proprietary stainless steel cleaner, obtainable from household stores or Belling Spares Department; call 01709 579907 and quote Belling 005

Do not use scouring pads or abrasive detergents, particularly on the stainless steel control panel and doors as damage may result.

Door Handles

Some proprietary cleaning products can attack plastic parts. Clean door handles/trims with warm soapy water only.

Care and Cleaning

Conventional Grill

The grill/top oven roof slides forward out of the grill compartment. Remember, never operate top oven/grill without its roof in place. The grill/top oven rod shelves and enamel parts of the oven or grill can be cleaned using household cream cleaner with a nylon pad or sponge. Heavier soiling may require the use of a proprietary oven cleaner or steel wool pad, but do not allow these to contact either the 'Cookclean' enamel or any of the door seals or plastic parts of the cooker.

Only use oven cleaners which carry the Vitreous Enamel Association Approvals symbol, and always follow the manufacturers instructions for use.

'Cookclean' Panels

The oven and grill side runners, and the fan oven back panel, are coated with a special 'Cookclean' enamel which will absorb and gradually vapourise any splashes which occur during cooking. The surface coating, which can be recognised by its matt finish, may be damaged by using aerosol oven cleaners, oven pads, detergents or scouring powders, and their use is not recommended.

Any particularly heavy soiling or splashing may indicate the cooking temperature has been too high, or that excess fat or water has been used when roasting. It can be removed by 'blotting' the surface with a paper towel or soft sponge, or by running the oven empty at maximum setting for about 2 hours.

Whilst normal cleaning can be carried out with these panels in place, they can be removed for cleaning manually, or for cleaning the rest of the oven interior. First, remove the oven shelves. The panels can then be removed by undoing the fixing screws.

To clean these 'Cookclean' panels by hand, scrub them with a nylon pad or brush, using warm soapy water. Rinse in cold water and 'blot' them dry with a paper towel or sponge. Do not rub the surface too dry as this can damage the 'Cookclean' finish. After cleaning, replace the panels immediately and run the oven at maximum setting for about 30 minutes to prevent deterioration of the enamel.

Grill/Top Oven

Refer to the instructions above for cleaning the 'Cookclean' removable side panels. To prevent stains from being burnt onto the grill pan, anti-splash tray, food support, and rod shelf, always clean using warm soapy water immediately after use taking care not to touch hot surfaces.

Wipe out the grill/top oven compartment, use a fine steel wool soap pad to remove stubborn stains from the rod shelf and the floor of the compartment.

Care and Cleaning

CLEANING THE DOORS

Take particular care not to damage the inner surface of the door inner glass that is coated with a heat reflective layer. Do not use scouring pads, or abrasive powder, which will scratch the glass. Ensure that the glass panel is not subjected to any sharp mechanical blows.

Stubborn stains can be removed by using a fine steel wool soap pad. For slight soiling the inner glass panel may be cleaned, while still warm, without removing it from the door. After cleaning, rinse and dry with a soft cloth.

SIDE OPENING DOORS

Cleaning the door glass is the same as the drop down doors, except take care to support the weight of the inner glass when removing and refitting.

DROP DOWN DOORS

Remove the door inner glass as follows.

1. Open the door fully and unscrew the two screws securing the glass panel so that the securing brackets can be turned. There is no need to remove the screws completely.

2. Turn the brackets so that the glass can be removed and cleaned at the sink (Fig. 1.)

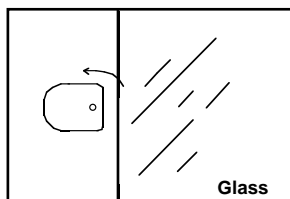

Fig. 1.

3. The inside of the outer door glass can now be cleaned while still fitted to the cooker.

NEVER OPERATE THE COOKER WITHOUT THE INNER DOOR GLASS IN POSITION.

Refit the door inner glass as follows.

1. **NOTE:** The inner door glass has a special reflective coating on one side. Replace the door inner glass so that the statement: **“IMPORTANT THIS FACE TOWARDS THE OVEN”** can be read from the inner side of the door.

2. Turn the two securing brackets back to their original position to retain the glass and tighten the screws. (Fig. 2.)

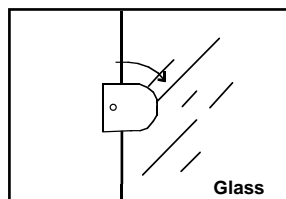

Fig. 2.

Care and Cleaning

Rod Shelves & Meat pan (where supplied)

Take care during cleaning not to damage or distort the Door Seal. Do not lift the Door Seal from the Oven Front frame, if necessary remove the seal by carefully unhooking the corner clips. Using a fine steel wool soap pad to remove stubborn stains from the rod shelves, meat pan and the floor of the oven. Refer to the instructions on page 40 for cleaning the 'Cookclean' panels.

NEVER use aerosol cleaners on this oven as they could adversely affect the fan motor unit, and cannot be wiped off the fan blade.

Replacement of Oven Lamps (where fitted)

WARNING: ISOLATE COOKER FROM SUPPLY BEFORE REPLACING LAMP.

Open the oven door and remove the rod shelves. Use a thick cloth to grip the light glass dome, unscrew anti-clockwise and lift out. Reach into the aperture with thick cloth, and unscrew the faulty lamp anti-clockwise (15W 300°C SES). Fit replacement lamp, refit glass lens.



The oven lamp is not covered by the guarantee.

A new lamp may be obtained from our Parts Department by calling:- 01709 579907.

N.B.

Care must be taken that Rating Plate edges are not lifted during cleaning and furthermore that the lettering is not blurred or removed.

Is there Something Wrong with your Cooker?

Fault finding guide	
Problem	Check
Nothing works	Before contacting your Belling Service Centre/Installer, check the problem guide below; there may be nothing wrong with your cooker. Is the main cooker wall switch turned on? Is the timer display blank? If the timer is not working it is likely that there is no electricity supply to your cooker.
Main Oven does not work. Grill works.	Ensure timer is set to manual by pressing button “  “ on the timer until the the 'Auto' symbol is off
Top Oven and Grill do not work. Main Oven works.	Operating the cooker under the following conditions may cause a safety device to operate. (a) grilling with the Top Oven door shut. (b) grilling for an excessively long period at a maximum setting. Switch off the appliance and allow the cooker to cool for approximately 30 minutes. Switch the cooker back on again and check that the grill/Top Oven is now operating correctly
Grill Does not work	Ensure that the Top Oven control is turned fully off.
Grill keeps turning on and off	When the grill control is operated at a setting less than '4' this is normal regulator operation, not a fault
Timer is flashing '000' and 'Auto'	The electricity supply to the cooker has been interrupted and the Timer must be reset.
Timer bleeping continually	Press button marked “  “.
Unable to set auto oven programme	Button “  “ on the timer refers to the duration of cooking (the time required to cook the food), not to stop the time. When the required 'Cook Time' and 'end time' have been set, the timer will calculate the start time for you.
Oven lamp does not work	The oven lamp is not covered by the guarantee. The part is easily changed - see the section on Oven Lamp Replacement. A new lamp may be obtained from our Parts Department by calling:- 01709 579907

Cooking Results Not Satisfactory?

Problem	Check
Grilling	
Uneven cooking front and back	Ensure that the grill pan is positioned centrally below the grill element.
Fat splattering	Ensure that the grill is not set too high.
Baking General	
Uneven rising of cakes	Ensure that the oven shelves are level by using a spirit level on the rod shelf and adjusting the wheels/feet. The oven should be checked both left to right and front to back.
Sinking of cakes	The following may cause cakes to sink: <ol style="list-style-type: none">1. Preheating of fan ovens.2. Cooking at too high a temperature.3. Using normal creaming method with soft margarine. (Use the all-in-one method).
Over/Under cooking Fast/Slow cooking	Refer to the cooking times and temperatures given in the cooking charts, however, it may be necessary to increase or decrease temperature by 10°C to suit personal taste. Do not use oven/meat tins greater than 56mm (2 ¹ / ₄ ") in height.
Top Oven Baking	
Uneven cooking front to back	Ensure that any cooking utensils are at least 100mm (4") from front of the shelf.
Uneven rising of cakes	Ensure that the shelf is level (see above) and that the food is positioned centrally in the oven.
Overcooking	Remember to reduce cooking temperatures by 10°C from standard recipes when using the Top Oven.
Food is taking too long to cook	Ensure that any cooking utensil used in the Top Oven is not larger than 300x225mm (12" by 9"), eg. the main oven meat pan. Only cook one item at a time to avoid overloading the oven.

Service

Please check your guarantee card for who to contact for service. Remember that service agents may charge for visits (even during the guarantee period) if nothing is found to be wrong with the appliance, so always check the instructions to make sure you have not missed anything.

Belling Appliances After Sales Division (Service)

Tel: 08457 454540 (all calls will be charged at local rate)

Before contacting a service agent, please note the following details about your cooker:

Model Number _____

Serial Number _____

Date of Purchase _____

In order to provide a complete service history for your Belling product, please ask the service engineer to record the appropriate details in the chart below.

Date	Nature of Fault	Parts Replaced or Repaired	Authorised Stamp or Signature

IMPORTANT NOTICE:- In line with our continuing policy of research and development, we reserve the right to alter models and specifications without prior notice.

This instruction manual is accurate at the date of printing but will be superseded and should be disregarded if specifications are changed.



Belling Appliances Ltd., Mexborough, South Yorkshire S64 8AJ