

Belling



Built-In Electric Oven

Model Nos.

XOU250

XOU251

XOU252

XOU270

XOU271

INSTALLATION AND USER INSTRUCTIONS



CONTENTS

INTRODUCTION	page	3
INSTRUCTIONS FOR THE INSTALLER	pages	4-6
FOR YOUR OWN SAFETY	page	7
DESCRIPTION OF THE APPLIANCE	page	8
KNOW YOUR OVEN	pages	9-10
AUTOMATIC OPERATION	page	11
OVEN TIMER OPERATION	pages	12-17
COOKING FUNTIONS	pages	18-19
COOKERY NOTES	page	20
FAN OVEN COOKING GUIDE	page	21
CONVENTIONAL OVEN COOKING GUIDE	page	22
GRILLING GUIDE	page	23
COOKING GUIDE	page	24
CLEANING AND MAINTENANCE	page	25
IS THERE SOMETHING WRONG WITH YOUR OVEN?	page	26
SERVICE	page	27

INTRODUCTION

YOUR BELLING OVEN

Thank you for purchasing a new Belling electric built-in oven.

Its stylish and practical design will enhance your kitchen and make cooking a pleasure.

Your oven specification will vary depending on model. It features a large electric oven with a grill. Some models feature a minute minder or clock/timer which features automatic oven switch on and off feature.

Even if you have used an electric oven before, it is important that you read these instructions thoroughly before starting to cook, as there may be many new features not featured on your previous oven. Pay particular attention to the installation and safety instructions.

GETTING HELP

If you have any problems with installation, operating or cooking with your Belling oven please check through these instructions thoroughly to make sure that you have not missed anything. If you still need help, then please contact (including a daytime telephone number if possible):

Consumer Relations Department
Belling Appliances Ltd.,
Talbot Road,
Mexborough.
South Yorkshire.
S64 8AJ.

BELLING HELP LINE Tel: 01709 579902

Please quote the oven model and serial number with your enquiries. This can be found on the serial number label beside the door seal or on the rating label, positioned on the right hand side panel of the appliance.

WARNING! For your own safety, make sure that these instructions on installation, use and maintenance are followed.

We advise you to keep these instructions in a safe place for future reference. If you sell or transfer ownership of this product, please pass on these instructions to the new owner.

This appliance conforms to EN55014 regarding suppression of Radio and Television reception interference.

INSTRUCTIONS FOR THE INSTALLER

TECHNICAL INFORMATION

- All installation and maintenance must only be carried out by qualified personnel. The manufacturer cannot be held responsible for any damage to persons or property resulting from an incorrect installation of the appliance.
- The safety and automatic adjustment devices of the appliance may, during its life, only be modified by the manufacturer or duly authorised supplier.
- In accordance with the electricity standard the appliance is type Y.
- The walls adjacent to and surrounding the appliance must be able to withstand a temperature rise of 65 K.

UNPACKING YOUR OVEN

- Remove all packaging before use and check to make sure that the appliance is in perfect condition. If you have any doubts do not use the appliance and call your supplier for advice. Do not move the appliance using the handles.
- Some parts on the appliance are protected by a plastic film. This protective film must be removed before the appliance is used. We recommend carefully slitting the plastic film along the edges with a sharp knife or pin. Our products use environmentally friendly packaging, which can be either recycled or disposed of in the appropriate manner.

The packaging materials should carefully discarded and not left within easy reach of children as they are a potential safety hazard.

DISPOSAL OF YOUR PRODUCT

To minimise the risk of injury to children please dispose of your product carefully and safely. Remove the mains cable (where fitted) by cutting off flush with the appliance and always ensure that no plug is left in a condition where it could be connected to the electricity supply. To help the environment, Local Authority instructions should be followed for the disposal of your product.

GENERAL

This appliance is designed specifically for domestic purposes and Belling Appliances Limited cannot accept responsibility if used in any other type of installation.

All Belling oven units are suitable for installation under Belling hob units.

This appliance must not be installed over any appliance that generates heat.

IMPORTANT

For your own safety, we recommend that your appliance is installed by a qualified electrician.

The oven should be installed in accordance with the latest Edition of the IEE Regulations.

TECHNICAL DATA

TYPE	XOU250/251/252/270/271
Dimensions for mounting H/W/D (mm)	570/560/540
Mains voltage	AC 230 V
Operating voltage	AC 230 V, 50 Hz
Upper element (kW)	0.7 (outer) + 1.8 (inner)
Lower element (kW) (XOU250/270/271 only)	1,6
Grill element (kW)	1,8
Fan element (kW) (XOU 251/252/270/271 only)	2,0
Fan only (W) (XOU 251/252/270/271 only)	25 - 29
Oven light (W) (n°2 XOU 270/271 only)	15W - E 14 - T300
Cooling fan (W)	18 - 22

WARNING: THIS APPLIANCE MUST BE EARTHED!

This oven should be installed by a competent electrician in accordance with the current edition of IEE Regulations.

This appliance must be earthed and connected to a 230volt, 50 Hz, single phase supply through a suitable oven control unit with a fuse rating of 20 amps. The control unit should incorporate a double pole switch having a contact separation of at least 3 mm in all poles and should be located adjacent to the oven to allow easy access in case of an emergency.

We recommend that you use a rubber cable (type HO 5RR-F) to connect the oven to the control unit or other protective cables with similar type characteristics. The minimum cable size is $3 \times 1.5 \text{ mm}^2$. The oven mains terminal block is located on the rear of the oven and should be connected as shown in the diagram. Access to the terminals is made possible by removing the screw immediately above the black plastic terminal cover, and hinging the cover downwards.

The power cable must be laid so that no parts of it ever reach an over temperature of 75K.

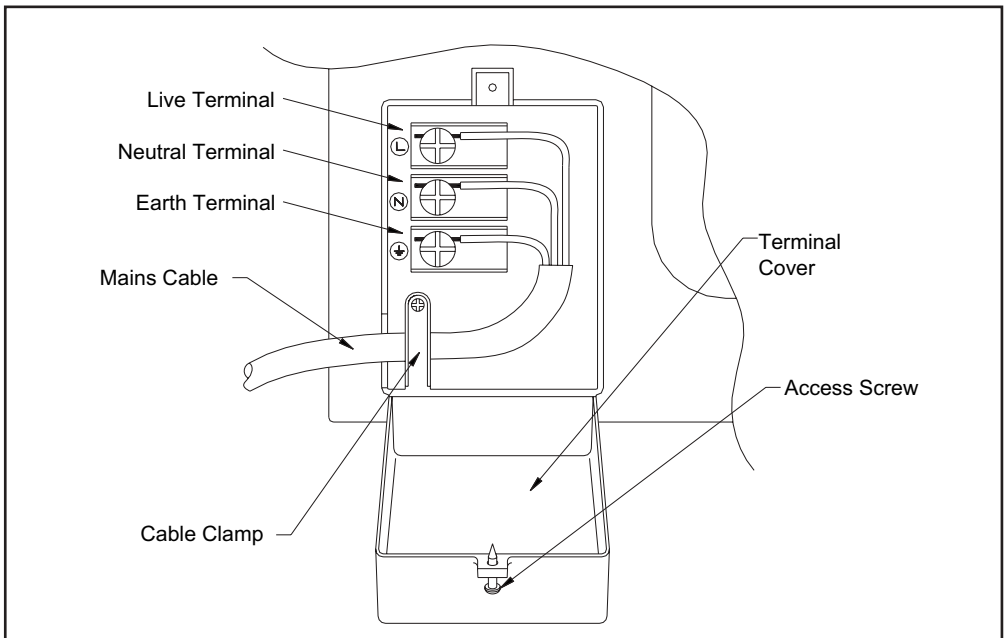

BUILDING-IN THE APPLIANCE

INSTALLATION DIMENSIONS

WARNING Always use the recommended measurements of the build-in opening, as shown in the table on page 5 and the diagrams below. To make sure the appliance is properly aerated, remove the rear panel of the base module or make a hole (A), as shown in the figure below.

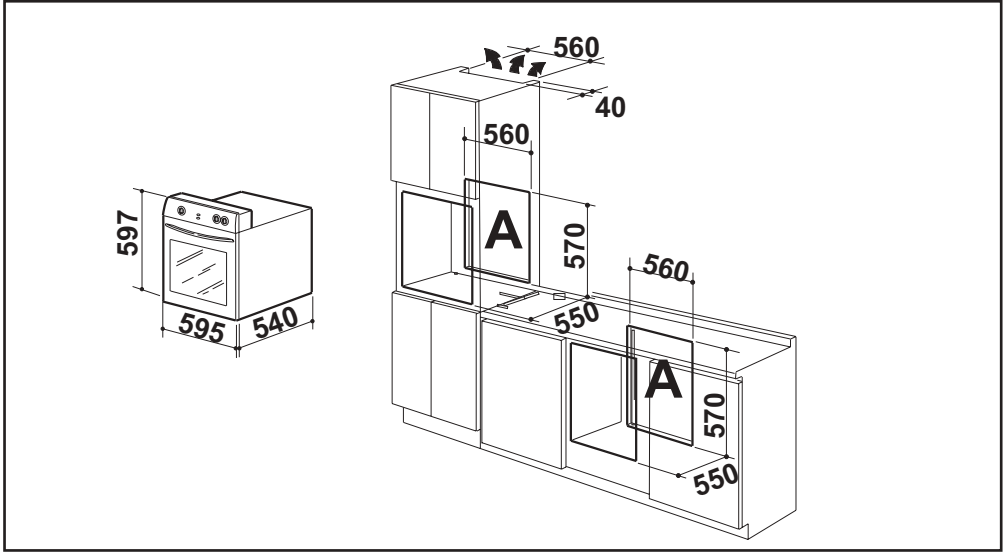

FIXING THE APPLIANCE

Push the appliance into the cabinet, open the oven door and drill pilot holes 2mm x 5mm deep, through the holes in the frame at the sides into the sides of the cabinet. Fix the oven to the cabinet with the enclosed screws (V).

Take care not to tighten the screws too much as this may cause damage to the cabinet sides or the appliance enamel.

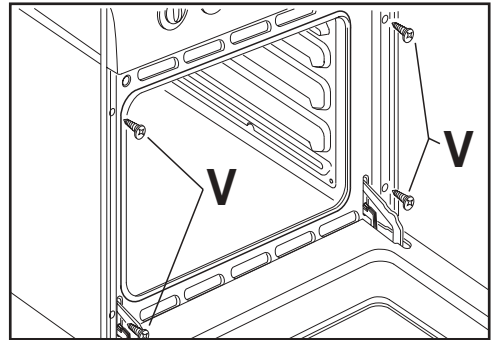

BEFORE COOKING

Before you cook for the first time, we recommend that you switch on each element in turn to burn off any odours remaining from manufacture. Simply operate the grill on maximum for a few minutes, and the oven for about 30 mins. Although the smell is harmless, we would recommend that you open the window to allow fresh air to circulate during this procedure.

When used properly your Belling oven is completely safe but as with any electrical product there are certain precautions that must be observed.

PLEASE READ THE PRECAUTIONS BELOW BEFORE USING YOUR APPLIANCE.

NEVER

- Never allow anyone except an authorised Belling Service Agent to service or repair your oven.
- Never remove any part of the oven other than those intended in normal use, or attempt to modify the oven in any way.
- Never use the oven for commercial catering. It is designed for domestic use and for cooking food only.
- Never allow young children to operate or play with the oven.
- Never line the shelves, floor, or sides of the oven or grill, with aluminium foil as overheating and damage may result.
- Never store anything which might catch fire in the oven or grill.
- Never heat unopened containers.
- Never dry clothes on the oven door.
- Never store flammable liquids, aerosols, etc. in adjacent cabinets.
- Never wear garments with long flowing sleeves whilst cooking.

ALWAYS

- Always take care when touching any part of the oven which may be hot. Use dry, good quality, oven gloves when removing or replacing food or dishes.
- Always stand back when opening the oven door to allow any build-up of heat or steam to disperse.
- Always keep the oven door closed when not in use to prevent accidents.
- Always keep your oven clean, as build-up of grease or fat from cooking may be a fire hazard.
- Always switch off at the mains before cleaning your oven.
- Always supervise children and pets, particularly when grilling, as exposed parts of the grill may become hot.
- Always make sure that all controls are switched off when you have finished cooking.
- Always remember that your oven may stay hot for a time even after you have finished cooking.
- Always keep ventilation slots clear of obstructions.
- Always keep children away from the oven when cleaning at maximum setting.

DESCRIPTION OF APPLIANCE

SHELF POSITIONS

Your oven features shelf supports formed into its cavity sides, which offer the user 3 different cooking positions.

ACCESSORIES

The oven is supplied with 2 oven shelves (A) (see below), which can be placed in any of the runners formed into the sides of the oven walls. The shelf positions are numbered from the bottom of each oven.

A grill pan (B), food support grid (C) and handle (D) is also included (see below), which is placed on top of the appropriate shelf. Use the grill pan (B) directly under a shelf for grilling a large amount of food.

When removing the tray from the oven, always use the handle (D) provided. Hook the handle to the edge of the tray and pull it out, slightly lifting it as you do so.

During cooking, **do not** place the grill pan on the floor of the oven, as damage to the appliance or adjacent cabinet may occur, due to overheating.

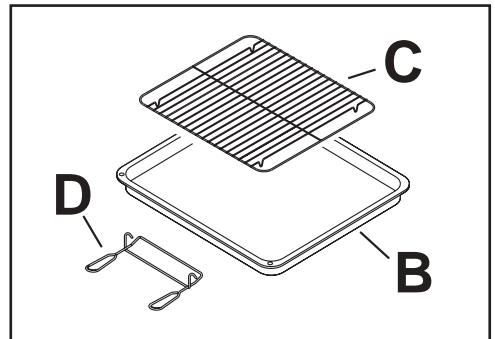
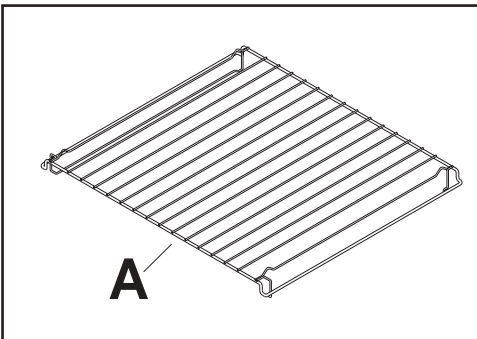
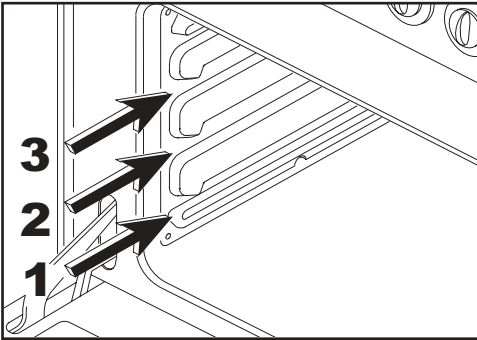

KNOW YOUR OVEN

CONTROL PANEL

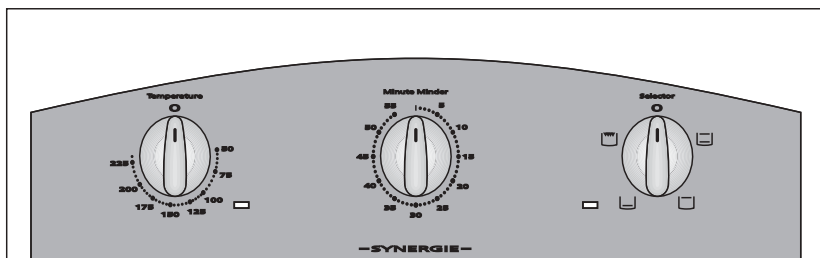

XOU250

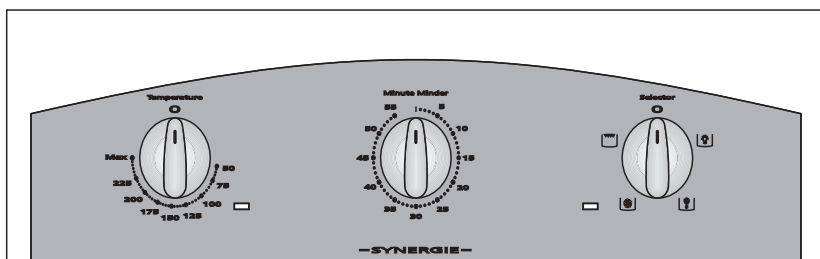

XOU251

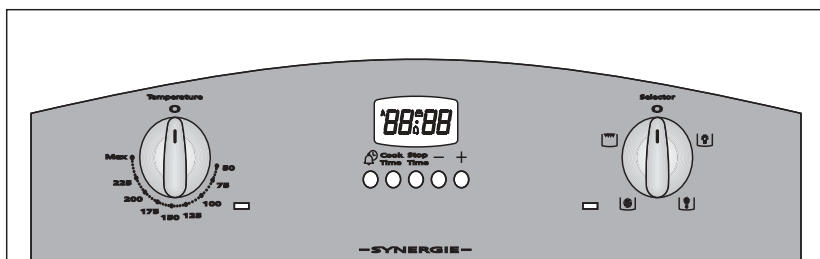

XOU252

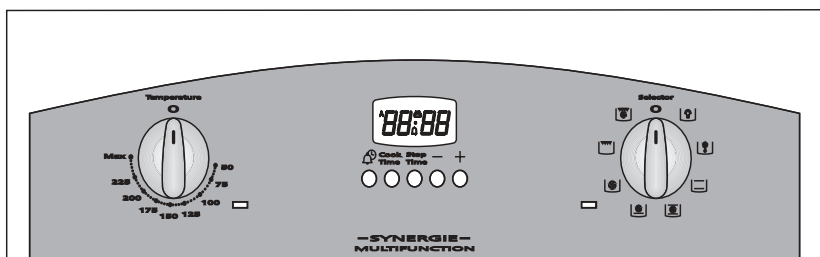









XOU270/271

KNOW YOUR OVEN

CONTROLS

FUNCTION SELECTOR

The cooking mode is selected using the function selector. The power on neon will illuminate whenever a function is selected. The functions available are as follows,

-  Light Only
-  Fan Defrost
-  Conventional Oven (top and base elements)
-  Conventional Oven with Fan Assist (top and base elements plus fan)
-  Base heat with Fan Assist
-  Fan Oven (rear element plus fan)
-  Grill
-  Fan Grill

THERMOSTAT

The Thermostat is used to set the desired cooking temperature, and is used in conjunction with the function selector. Do not set a temperature when using the oven in light only and fan defrost modes.

Temperature is set by turning the control clockwise to the desired setting, with a range between 50°C and approximately 230°C being available

The oven indicator light will immediately come on and remain on until the oven reaches the set temperature. This light will then automatically go on and off during cooking as the oven thermostat maintains the correct temperature.

WARNING: DURING USE THE APPLIANCE BECOMES HOT. CARE SHOULD BE TAKEN TO AVOID TOUCHING HEATING ELEMENTS INSIDE THE OVEN.

MINUTE MINDER

The minute minder can be set up to 60 minutes. Setting the minute minder does not affect any oven function.

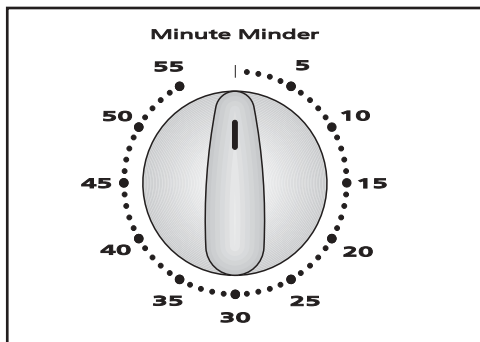

The oven programmer offers you the following features:

1. Time of Day
2. Minute Minder
3. Automatic Cooking with cook and delay cooking functions.

We recommend following the guidelines below, to ensure the best performance from your oven when using automatic cooking programs,

1. Select foods which will take the same time to cook and require approximately the same temperature.
2. Set the oven programmer so that the food has just finished or about to finish cooking on your return to the oven. This will ensure the food has not cooled down and does not require reheating before serving.
3. Food should be as cold as possible when it goes into the oven, ideally straight from the refrigerator. Frozen meat and poultry should be thawed thoroughly before it is put in the oven.
4. We advise that warm food should never be placed in the oven if there is to be a delay period. Stews prepared by frying the meat and vegetables should be cooked as soon as possible.
5. We advise dishes containing left-over cooked poultry or meat, for example
Shepherds Pie, should not be cooked automatically if there is to be a delay period.
6. Stews and joints should be cooked by the long slow method, so that the delay period is kept to a minimum.
7. On warm days, to prevent harmful bacterial growth in certain foods (i.e. poultry, joints, etc) the delayed start should be kept to a minimum.
8. Wine or beer may ferment and cream may curdle during the delay period, so it is best to add these ingredients just before serving.
9. Foods which discolour should be protected by coating in fat or tossing in water to which lemon juice has been added, prior to placing food in the oven.
10. Dishes containing liquid should not be filled too full to prevent boiling over.
11. Foods should be well sealed (but not airtight) in a container to prevent the loss of liquid during cooking. Aluminium foil gives a good seal.
12. Ensure food is cooked thoroughly before serving.

OVEN TIMER OPERATION

ELECTRONIC TIMER

The timer display is in 24 hour clock format.

Ensure that the correct time of day is always set before using your cooker.

Description:

A will light:

- When the timer is first turned on it will flash (It should go out when a time of day is set).
- When an Auto Cooking programme has been set.

 This "Cookpot" symbol will light up either:

- When the cooker is in "Manual Mode".
- When you press the Cook Time button and set a length of time for an Automatic Cooking programme.

Note:  symbol will light up during Automatic Cooking.

 Will light up when you select a Minute Minder period and will remain lit for the period set.



MINUTE MINDER (1)

Here you can set a time period of up to 23 hours and 59 minutes that will count down. When it reaches zero the timer will bleep.

e.g. If you set 20 minutes, the timer will start bleeping 20 minutes later.

COOK TIME (2)

Cook time is the actual length of time for which, the timer will switch the oven(s) on as part of an "Automatic Cooking" programme.

e.g. If you set 2 hours, the food will be cooked for 2 hours.

STOP TIME (3)

The time of day at which you want an automatic cooking programme to end.

e.g. If you set a cook time for 2 hours, and stop time of 11:00. The timer will switch the oven(s) on at 9:00 and turn the oven(s) off at 11:00. You will hear a bleep at 11:00 to indicate that the automatic cooking programme has finished.

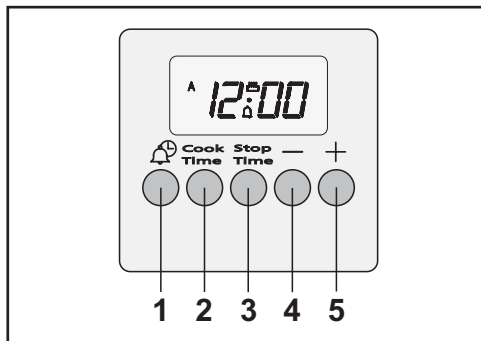

NOTES



- When setting an automatic cooking programme you will need to set the oven control(s) to the required temperature(s) when you set the timer.
- If an automatic cooking programme has been set the oven(s) will only operate during the pre-programmed time.

- (4) and + (5)





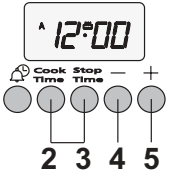

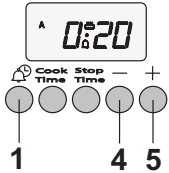

- Used to adjust the various timer function settings.

OVEN TIMER OPERATION CONTINUED

SETTING THE TIME OF DAY

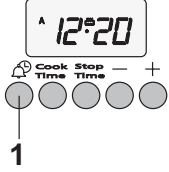
	<p>Step 1</p> <p>Step 2</p>	<ul style="list-style-type: none"> ➤ Make sure all oven controls are turned OFF. ➤ Check the electricity supply to the cooker is turned ON. <p>When switched on the display will show 0.00 and the A symbol, both will be flashing.</p>
	<p>Step 3</p> <p>Step 4</p> <p>Step 5</p>	<ul style="list-style-type: none"> ➤ Press & hold in both the Cook Time (2) & Stop Time (3) buttons together. ➤ With the Cook Time & Stop Time buttons still held in, press either the + (5) or - (4) buttons to set the correct time of day. ➤ Release all the buttons simultaneously. <p>The time of day is now set and the  symbol will light up to show that the timer is in Manual Mode.</p> <p>NOTE: To change the time of day repeat steps 3, 4 & 5 above.</p>

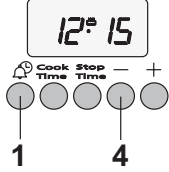
SETTING THE MINUTE MINDER

	<p>Step 1</p> <p>Step 2</p> <p>Step 3</p> <p>Step 4</p>	<ul style="list-style-type: none"> ➤ Ensure the time of day is set correctly. ➤ Press and hold the  (1) minute minder button. ➤ With the button still held in set the required minute minder time using + (5) and - (4) buttons. A  symbol will light up. ➤ Release all buttons and the timer display will revert back to the time of day. <p>The  symbol will remain lit to signify that a minute minder period has been set.</p>
	<p>Step 5</p>	<p>At the end of the set time a beeping sound will be heard and the symbol will go out.</p> <p>The beeping sound will continue for several minutes unless cancelled (See Step 5).</p> <ul style="list-style-type: none"> ➤ To cancel the beeping sound press the  (1) minute minder button. The time display will revert back to the time of day after the button is released.
	<p>Step 1</p> <p>Step 2</p>	<p>To cancel the minute minder before the minute minder period has finished.</p> <ul style="list-style-type: none"> ➤ Press the  (1) minute minder button ➤ Press the - (4) button until 0.00 appears in the display window.
<p>When the minute minder has been set, the time remaining can be checked at any time by simply pressing the  minute minder button.</p>		

OVEN TIMER OPERATION CONTINUED







AUTOMATIC COOKING PROGRAMMES

There are two automatic cooking programmes that can be selected using your timer:



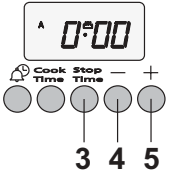

- (a) To set the timer to switch the oven(s) ON and OFF automatically.
- (b) To set the timer to switch on immediately and OFF automatically after a set Cook Time.

(a) To set the timer to switch the oven(s) ON and OFF automatically.

This allows you to cook at a specific time for a chosen period before the oven switches off automatically.

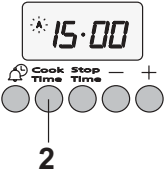

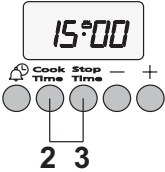



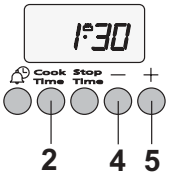

<p>Step 1 ➤ Check that the correct time of day is set. If not follow instructions for setting the time of day.</p> <p>Step 2 ➤ Place food onto the correct shelf position in the oven and close the oven door.</p>	<p>Step 3</p> <p>Step 4</p>	<ul style="list-style-type: none"> ➤ Press and hold the Cook Time (2) button. The display will read 0.00 with the cookpot symbol  lit. ➤ With the Cook Time button still held in set the required cook period using + (5) and - (4) buttons.
		<p>Release the buttons and the timer display will revert to the time of day with the A symbol and symbol  lit.</p>
	<p>Step 5</p> <p>Step 6</p>	<ul style="list-style-type: none"> ➤ Press and hold the Stop Time (3) button. The display will read the earliest possible time for the Cook Time that you have set above. ➤ With the Stop Time button still held in, use the + (5) and - (4) buttons to set the Stop Time. i.e. the time you require the oven to switch off.
		<p>Release all the buttons and the timer will revert back to the time of day.</p> <p>The A symbol will remain lit to signify that an automatic cooking programme has been set.</p> <p>The  symbol will go out.</p> <p>When the auto cook programme starts the  symbol will then light up again.</p>
<p>Step 7 ➤ Turn the oven control(s) to the required temperature and if necessary select the appropriate oven function.</p>		

OVEN TIMER OPERATION CONTINUED

	<p>Step 8</p>	<p>At the end of the automatic cook period the A symbol will flash and an intermittent beeping sound will be heard. The  symbol will go out.</p> <p>The beeping sound will continue for several minutes unless cancelled (see Step 8). The A symbol will continue to flash until the timer is returned to manual operation (see below).</p> <ul style="list-style-type: none"> ➤ Press the Cook Time (2) button to cancel the beeping sound.
	<p>Step 9 Step 10</p>	<ul style="list-style-type: none"> ➤ Turn the oven control(s) to the OFF position. ➤ Press the Cook Time (2) and Stop Time (3) buttons together to return the oven to manual operation. The A symbol will go out and the  symbol will light up.
<p>When cooking automatically the Cook Time can be checked at any time by simply pressing the Cook Time (2) button and the Stop Time by pressing the Stop Time (3) button.</p> <p>To cancel the auto-cooking programme before or after auto cooking starts, press the Cook Time (2) and the Stop Time (3) buttons together. This will return the cooker to manual operation.</p>		

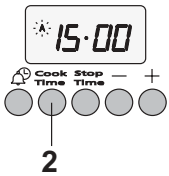
OVEN TIMER OPERATION CONTINUED

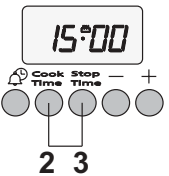
(b) To set the timer to switch ON immediately and OFF automatically after a set Cook Time.

<p>Step 1 ➤ Check that the correct time of day is set. If not follow instructions for setting the time of day.</p> <p>Step 2 ➤ Place food onto the correct shelf position in the oven and close the oven door.</p> <p>Step 3 ➤ Turn the oven control(s) to the required temperature and if necessary select the appropriate oven.</p>		
	<p>Step 4</p>	<p>➤ Press and hold the Cook Time (2) button, the display will read 0.00 and the  symbol will light up.</p> <p>With the Cook Time button still held set the required Cook Time using the + (5) and - (4) buttons, the A symbol will light up. e.g. 1 hour 30 minutes.</p> <p>Note: The Cook Time is the length of time the food requires to cook.</p>
	<p>Step 5</p>	<p>➤ Release all buttons.</p> <p>➤ The timer display will revert to the time of day with the A and  symbols remaining lit.</p>
	<p>Step 6</p>	<p>At the end of the Cook Time the A symbol will flash and an intermittent beeping sound will be heard. The  symbol will go out. The beeping sound will continue for several minutes unless cancelled (see Step 6). The A symbol will continue to flash until the timer is returned to manual operation (see below).</p> <p>➤ Press the Cook Time (2) button to cancel the beeping sound.</p>
	<p>Step 7 Step 8</p>	<p>➤ Turn the oven control(s) to the OFF position.</p> <p>➤ Press the Cook Time (2) and Stop Time (3) buttons together to return the oven to manual operation. The A symbol will go out and the  symbol will light up.</p>

When cooking automatically the Cook Time can be checked at any time by simply pressing the **Cook Time (2)** button and the Stop Time by pressing the **Stop Time (3)** button.

To cancel the auto-cooking programme before or after auto cooking starts, press the **Cook Time (2)** and the **Stop Time (3)** buttons together. This will return the cooker to manual operation.

OVEN TIMER OPERATION CONTINUED

1. To cancel the automatic cooking programme before or after automatic cooking starts, press the **Cook Time (2)** and **Stop Time (3)** buttons together, this will return the cooker to manual operation.
2. When cooking automatically the Cook Time can be checked at any time simply by pressing the **Cook Time (2)** button.
3. When cooking automatically the Stop Time can be checked at any time by simply pressing the **Stop Time (3)** button.
4. Having set a Cook Time and Stop Time an electronic device stores the information. The device within the timer will switch the oven(s) on and off at the required time.
5. When setting an automatic cooking programme and a mistake is made, to clear:
 - (a) Press the **Cook Time (2)** and **Stop Time (3)** buttons together to return the cooker to Manual operation.
 - (b) Start the sequence again.
6. If at any time the display shows three flashing zero's .  It is likely that the electricity supply to the oven has been interrupted. Reset the timer to the correct time of day. Food in the oven may therefore not have been cooked, before serving check food is thoroughly heated and completely cooked.
7. To set each function always press and hold the required function button and at the same time press + **(5)** or - **(4)** buttons.

COOKING FUNCTIONS



FAN OVEN

The oven is heated by an element at the rear of the oven. Air is drawn into the hole in the center of the oven's rear panel by a circulating fan, before being forced over the radial fan element and back into the oven cavity.

This heating system is useful for baking biscuits, cakes, many small pieces of meat, the accelerated thawing of frozen foods and preserving/drying fruits and vegetables.

- The oven heats up quickly but preheating is usually required. Please refer to the table provided. Food can be cooked simultaneously on one or two levels.
- If you need to put food in a preheated oven, please wait until the indicator neon goes off before putting food in the oven.
- Feel free to use your own cake tins and other smaller tins.
- As you can insert two or even three trays in the oven simultaneously (when baking biscuits for example), this additional economy saving feature saves on further time and money.
- Baking temperatures are lower, therefore the loss of nutrition value of the food is reduced, as is also energy consumption.



CONVENTIONAL OVEN (TOP AND BOTTOM ELEMENTS)

The oven is heated by elements at the top of the oven and underneath the floor of the oven.

This heating mode can be used for preparing various foods: meat, bread, cakes, pies or even preparing whole meals.

- With this heating system you can only use one level at a time.
- If you need to put food in a preheated oven, please wait until the indicator neon goes off before putting food in the oven.
- Feel free to use your own cake tins and smaller tins other than the ones included
- When roasting meat please remember that larger and thicker pieces of meat should be roasted on the lower shelf position at a lower temperature, and smaller thinner pieces can be cooked on the middle shelf position at a higher temperature setting.

- Some 5-10 minutes before the food has completed cooking, switch the oven OFF. This will save on energy.
- After roasting is finished and before cutting the meat; wait for 5-10 minutes; this allows the meat juices to settle inside the meat.
- You can cook frozen meat without thawing it first, just bear in mind that the roasting time will be longer, depending on the size of the meat joint.



CONVENTIONAL OVEN WITH FAN ASSIST ONLY

The oven is heated by elements at the top of the oven and underneath the floor of the oven, with air circulated by the fan. This heating mode can be used for preparing various foods: meat, bread, cakes, pies on one or two shelves.

COOKING FUNCTIONS CONTINUED



CONVENTIONAL GRILLING

This heating system is used for cooking pieces of meat, not thicker than 3 cm (e.g. steaks, chops, sausages, fish) and for browning sandwiches, vegetables and sweet dishes.

Grilling should always be carried out with the door closed.

- We recommend that the grill is preheated for 5 minutes before cooking.
- Use meat suitable for grilling and cut it into uniform pieces. Add spices, brush with oil and place on the pre-oiled wire shelf. Place the shelf in the top shelf position and insert the enamel drip tray underneath the grill. After grilling, add salt if desired, and serve.
- The choice of which shelf position to use, temperature setting and the grilling time depends on the kind of meat being grilled as well as the thickness and quality of the meat pieces. Smaller and thinner pieces of meat can be grilled using a higher temperature and positioned closer to the grill element. With larger thicker pieces use a lower temperature and place further away from the grill element. The cooking time also depends on how well you want your food to be done.
- Turn the food over once after having cooked them for about 2/3 of the required cooking time.
- Frozen meat should be thawed thoroughly first.



BOTTOM HEAT WITH FAN

Using the bottom heating element and fan is particularly useful for baking moulded cakes with raisins, brioches, for warming ready-made dishes and dishes requiring intensive browning on the bottom.

Use only small-size baking dishes and cake tins with the rims not higher than the cake. Higher rims prevent cakes from browning on the top.



FAN DEFROST

When the fan only is in operation, air is circulated evenly throughout the entire oven and is useful for defrosting frozen dishes that need to be thawed at room temperature, and will be consumed unheated (cream, custard pastry, tarts, fruit etc.)



FAN GRILLING

This function uses the grill and fan. A uniform air circulation is created which makes this system perfect for roasting larger joints of meat (1 kg or more). It gives similar results to cooking on a rotisserie.

- Preheating is not necessary.
- Place the meat (oiled and salted) on a pre-oiled wire shelf. Place the shelf on level 2 and insert the enamel drip tray underneath at level 1.
- You can roast more joints at the same time but only on one level.
- When roasting, remember that you do need to turn the meat over in the middle of cooking.
- After the roasting is finished let the meat sit for 10 minutes before cutting it.

TEMPERATURE AND TIME

When two shelves are used to cook large quantities of food for home freezing or parties, it may be necessary to increase the cooking times given in the charts on page 21 by a few minutes, to allow for the loss of heat due to the extra time taken to load the oven, and the larger mass of food. Baking trays should allow an equal gap on all sides of the oven.

TO PREPARE MEAT AND POULTRY FOR ROASTING IN YOUR FAN OVEN

- (a) Wipe the meat or poultry, dry well and weigh it. Meat which has for been stored in a refrigerator should be allowed to come to room temperature before cooking, and frozen meat or poultry must be completely defrosted before placing in the oven.
- (b) The weight of any stuffing used should be added before calculating the cooking time.
- (c) Place meat/poultry in a suitable meat pan. Small joints weighing less than 1.75kg (3 1/2 lbs) should be roasted in a smaller meat pan/tin - or they may be 'pot roasted' - a small joint or a large meat pan causes unnecessary oven splashing and evaporation of meat juices.
- (d) Additional fat should not be added, except for veal, very lean meat or poultry which can either be 'larded' with fat bacon or brushed very sparingly with cooking oil or melted fat.
- (e) Beef, lamb, mutton and poultry may be dusted lightly with seasoned flour to give a crisp outer surface. The skin of duck and goose should be pricked to release excess fat during cooking, and the rind of pork should be scored, brushed lightly with oil, and rubbed with salt to give crisp crackling.
- (f) Meat and poultry wrapped in, or covered with a tent of aluminium foil will be juicy and tender. Roasting bags offer the same advantages. Always follow the manufacturer's pack instructions, and remember to reduce the temperatures given for conventional ovens by approximately 25°C and the time by approximately 10 minutes per hour.
- (g) Potatoes for roasting only require to be brushed with cooking oil or melted fat.
- (h) It is not necessary to baste when roasting in an electric oven and stock or liquid should not be added to the meat pan since this only causes unnecessary soiling, steam and condensation.

FROZEN MEAT AND POULTRY

Joints of meat and whole birds should be defrosted slowly, preferably in a domestic refrigerator (allowing 5-6 hours per 450g, 1 lb), or at room temperature (allowing 2-3 hours per 450g, 1 lb).

Frozen meat or poultry must be completely defrosted before placing in the oven. It is essential to wash thoroughly and cook meat and poultry immediately after defrosting.

FAN OVEN COOKING GUIDE

 The cooking charts below serve as a guide for positioning and temperature for cooking in the fan oven. Always preheat the oven until the indicator neon goes out, unless otherwise stated.

MEAT	Preheat	Thermostat Setting (°C)	Time (approximate)	Position in Oven (from base)
Beef / Lamb (slow roasting)	Yes	170 / 180	35 mins per 450g (1 lb) + 35 mins over	1 or 2
Beef / Lamb (foil covered)	Yes	190 / 200	35-40 mins per 450g (1 lb)	1 or 2
Pork (slow roasting)	Yes	170 / 180	40 mins per 450g (1 lb) + 40 mins over	1 or 2
Pork (foil covered)	Yes	190 / 200	40 mins per 450g (1 lb)	1 or 2
Veal (slow roasting)	Yes	170 / 180	40-45 mins per 450g (1 lb) + 40 mins over	1 or 2
Veal (foil covered)	Yes	190 / 200	40-45 mins per 450g (1 lb)	1 or 2
Poultry / Game (slow roasting)	Yes	170 / 180	25-30 mins per 450g (1 lb) + 25 mins over	1 or 2
Poultry / Game (foil covered)	Yes	190 / 200	25-30 mins per 450g (1 lb)	1 or 2
Casserole Cooking	Yes	150	2 - 2½ hrs	1 or 2

BAKING	Preheat	Thermostat Setting (°C)	Time (approximate) in mins	Position in Oven (from base)
Scones	Yes	210 / 225	10 - 15	1 and 3
Small Cakes	Yes	200 / 210	15 - 20	1 and 3
Victoria Sandwich	Yes	180 / 190	30 - 35	1 and 3
Sponge Sandwich (fatless)	Yes	180 / 190	20 - 25	1
Swiss Roll	Yes	210 / 220	10 - 15	1
Semi-rich fruit cakes	Yes	160 / 170	60 - 75 (7" tin)	2
Rich Fruit Cakes	No	130 / 140	Time dependant on size	1
Shortcrust Pastry	Yes	220 / 230	Time dependant on recipe	2
Puff Pastry	Yes	200 / 210	Time dependant on recipe	1
Yorkshire Pudding	Yes	190 / 210	30 - 40	1 and 2
Individual Yorkshire Puddings	Yes	200 / 210	25 - 35	1 and 2
Milk Pudding	Yes	130 / 140	90 - 120	1
Baked Custard	Yes	140 / 150	40 - 50	1
Meringues	Yes	100	150 - 180	1

Note: If soft tub margarine is used for cake making, we would recommend using the all in one method and to reduce the temperature by 10°C. Temperatures recommended in this chart refer to cakes made with block margarine or butter only.

CONVENTIONAL OVEN COOKING GUIDE



The cooking charts below serve as a guide for positioning and temperature for cooking in the conventional oven. Always preheat the oven until indicator neon goes out, unless otherwise stated.

MEAT	Preheat	Thermostat Setting (°C)	Time (approximate)	Position in Oven (from base)
Beef / Lamb (slow roasting)	Yes	170 / 190	35 mins per 450g (1 lb) + 35 mins over	2
Beef / Lamb (foil covered)	Yes	190 / 210	35-40 mins per 450g (1 lb)	2
Pork (slow roasting)	Yes	170 / 190	40 mins per 450g (1 lb) + 40 mins over	2
Pork (foil covered)	Yes	190 / 210	40 mins per 450g (1 lb)	2
Veal (slow roasting)	Yes	170 / 190	40-45 mins per 450g (1 lb) + 40 mins over	2
Veal (foil covered)	Yes	190 / 210	40-45 mins per 450g (1 lb)	2
Poultry / Game (slow roasting)	Yes	170 / 190	25-30 mins per 450g (1 lb) + 25 mins over	2
Poultry / Game (foil covered)	Yes	190 / 210	25-30 mins per 450g (1 lb)	2
Casserole Cooking	Yes	150	2 - 2½ hrs	2

BAKING	Preheat	Thermostat Setting (°C)	Time (approximate) in mins	Position in Oven (from base)
Scones	Yes	215 / 220	8 - 12	2
Small Cakes	Yes	160 / 170	20 - 25	2
Victoria Sandwich	Yes	150 / 160	30 - 35	2
Sponge Sandwich (fatless)	Yes	190 / 200	23 - 28	2
Swiss Roll	Yes	210 / 220	10 - 15	2
Semi-rich fruit cakes	Yes	160 / 170	60 - 75 (7" tin)	2
Rich Fruit Cakes	Yes	125 / 135	Time dependant on size	2
Shortcrust Pastry	Yes	190 / 210	Time dependant on recipe	2
Puff Pastry	Yes	210 / 220	Time dependant on recipe	2
Yorkshire Pudding	Yes	195 / 215	30 - 40	2
Individual Yorkshire Puddings	Yes	200 / 215	20 - 30	2
Milk Pudding	Yes	140 / 150	90 - 120	2
Baked Custard	Yes	145 / 160	40 - 50	2
Meringues	Yes	100	150 - 180	2

Note: If soft tub margarine is used for cake making, we would recommend using the all in one method and to reduce the temperature by 10°C. Temperatures recommended in this chart refer to cakes made with block margarine or butter only.

GRILLING GUIDE

CONVENTIONAL GRILLING

 The cooking chart below serves as a guide as to how various food types may be cooked. Preheat the grill for 5 minutes before use.

Food	Shelf position from base of oven	Grilling Temperature (°C)	Approx. Cooking Time
Toasting of bread products	3	200-220	45 seconds per side
Small cuts of meat - Sausages, bacon	3	180-200	10 - 30 mins (Depends on size and thickness)
Chops, etc. Gammon Steaks	2 or 3	180-200	10 - 30 mins (Depends on size and thickness)
Fish. Whole, Fillets	2 or 3	180 - 200	15 mins
Fish in breadcrumbs	2 or 3	180-190	15 mins
Pre-cooked potatoe	3	200	30 mins
Pizzas	3	170 - 180	10 - 12 mins
Browning of food	2 or 3 (dish placed directly on shelf)	200 - 220	5 - 7 mins

After use, always return controls to the off position.

COOKING GUIDE FAN GRILLING

 Before cooking place the drip tray under the wire shelf. Position the meat centrally below the grill element. Cook from a cold start ensuring meat is turned over half way through cooking.

Food	Shelf position from base of oven	Grilling Temperature (°C)	Approx. Cooking Time
Chicken weight 1.5-2kg	1 or 2	130 - 150	25mins / 450g +25-30mins
Chicken weight 1.0kg	2	160 - 170	20mins / 450g +20-25mins
Beef	2	150	20-25mins/450g +20-25mins
Pork (leg)	2	140 - 160	40-45mins/450g+40-50mins

COOKING GUIDE BOTTOM HEAT AND FAN



Preheat oven for 10-15mins prior to use

Dish	Shelf Position (from bottom)	Thermostat Setting (°C)	Cooking Time (min.)
Brioche	2	160	15 - 20
Shortbread	2	130-140	25
Pizza	2	170-180	10- 15
Bakewell Tart	2	165-175	30 - 40

COOKING GUIDE CONVENTIONAL OVEN WITH FAN ASSIST



Preheat oven for 10-15mins prior to use

DISH	Preheat	Thermostat Setting (°C)	Time (approximate) in mins	Position in Oven (from base)
Scones	Yes	170 / 180	8 - 12	1 and 3
Small Cakes	Yes	130 / 140	15 - 20	1 and 3
Victoria Sandwich	Yes	120 / 130	27 - 33	1 and 3
Semi-rich fruit cakes	Yes	140 / 150	60 - 75 (7" tin)	2
Shortcrust Pastry	Yes	150 / 160	Time dependant on recipe	2
Rich Fruit Cakes	Yes	210 / 220	Time dependant on recipe	2
Yorkshire Pudding	Yes	195 / 215	30 - 40	2
Individual Yorkshire	Yes	100 / 120	Time dependant on size	2
Pizza	Yes	170 / 180	10 - 15	2

CLEANING AND MAINTENANCE

TURN OFF THE OVEN ELECTRICITY SUPPLY BEFORE CLEANING.

OVEN EXTERIOR

All the parts of the oven exterior (stainless steel, side panels, door glass) must be cleaned frequently with a mild detergent and a little water and then dried with a soft cloth.

Do not wash the parts if they are still hot and never use abrasive powders, pads or corrosive spray products. Do not leave vinegar, coffee, milk, salty water or the juice of lemon or tomato on the surface for any length of time.

On painted or stainless steel surfaces, do not use solvents to remove spots or label adhesive.

Stainless steel cleaner can be obtained from the Belling Spares department tel. 01709 579907, quoting reference number Belling 005.

OVEN CAVITIES

The oven should be cleaned after each use to remove cooking residuals and grease which, if burnt on when the oven is used again, will form deposits or stains, as well as unpleasant smells. Do not leave vinegar, coffee, milk, salty water or the juice of lemon or tomato on enamelled surfaces for any length of time. Always wash the accessories used. The rod shelves, heat deflector shield and grill can be cleaned using household cream cleanser with a nylon pad or sponge. Heavier soiling may require the use of a proprietary oven cleaner or steel wool pad, but do not allow these to contact the door seals or plastic parts of the oven.

Only use oven cleaners which carry the Vitreous Enamel Development Council's Approvals symbol, and always follow the manufacturers instructions for use. Do not spray or wash the elements or thermostat bulb with acid-based products (check the information label on the product you are using).

The manufacturer cannot be held responsible for any damages caused by incorrect cleaning.

OVEN DOOR SEAL

The oven door seal guarantees the correct functioning of the oven. We recommend you:

- clean it, avoiding abrasive products.
- check its condition from time to time.

CHANGING THE OVEN LAMP

WARNING: TURN OFF THE OVEN ELECTRICITY SUPPLY BEFORE REPLACING LAMP.

Open the oven door and remove the rod shelves. Use a thick cloth to grip the light glass lens (C) and bulb, unscrew anti-clockwise and lift out.

Reach into the aperture, and carefully unscrew the faulty lamp (L) anti-clockwise. Fit replacement lamp (15W 300°C SES), and refit lens. If necessary clean the lens in warm soapy water before drying completely.

NOTE: Oven bulb replacement is not covered by your guarantee, please telephone our Spares Department on 01709 579907 for a replacement.

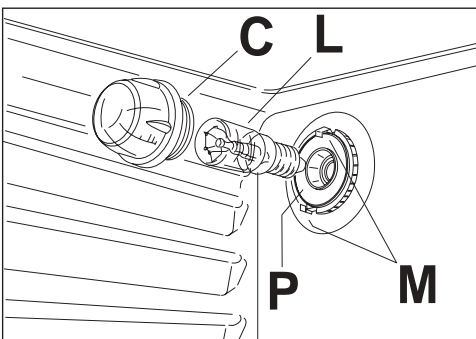

IS THERE SOMETHING WRONG WITH YOUR OVEN?

Fault finding guide	Before contacting your Belling service Centre / Installer, check the problem guide below: there may be nothing wrong with your oven
Problem	Check
Nothing works	Is the main oven wall switch turned on? Is the timer display blank? If the timer is not working it is likely that there is no electricity supply to your oven.
Timer flashing	The electricity supply to the oven has been interrupted. The timer must be reset.
Timer bleeping	Press timer button 4 to cancel.
Grill keeps turning on and off.	This is normal during use, as the grill maintains temperature.
Oven lamp does not work.	The oven lamp is not covered by the guarantee. The part is easily changed - see the section on Oven Lamp Replacement. A new lamp may be obtained from our spares department by calling :- 01709 579907

Are cooking results not satisfactory?

Problem	Check
Grilling Uneven Cooking front to back	Ensure that the grill is positioned centrally below the grill element
Baking - General Uneven rising of cakes	Ensure that the oven shelves are level by using a spirit level on the rod shelf and adjusting the wheels/feet. The oven should be checked both left to right and front to back.
Sinking of cakes	The following may cause cakes to sink: 1. Preheating of fan ovens. 2. Cooking at to high a temperature. 3. Using normal creaming method with soft margarine. (Use the all-in-one method - see Cook Book supplied)
Over/Under cooking Fast/Slow cooking	Refer to the cooking times and temperatures given in the charts provided, however, it may be necessary to increase or decrease temperatures by 10°C to suit personal tastes. Do not use oven/meat tins greater than 56mm (2 1/4") in height.

SERVICE

Please check your guarantee card for who to contact for service. Remember that service agents may charge for visits (even during the guarantee period) if nothing is found to be wrong with the appliance, so always check the instructions to make sure you have not missed anything.

Belling Appliances After Sales Division (Service)

Tel: 08457 454540 (all calls will be charged at local rate)

Before contacting a service agent, please note the following details about your oven:

Model Number

Serial Number

Date of Purchase

In order to provide a complete service history for your Belling product, please ask the service engineer to record the appropriate details in the chart below.

Date	Nature of fault	Parts Replaced or Repaired	Authorised Stamp or Signature



Belling Appliances Ltd., Mexborough, South Yorkshire S64 8AJ

XOU250001 11/01

