

Belling

IH60RXL Induction Hob

User & Installation Instructions



Contents

Before using your appliance	3
Safety	4
Safety and induction	6
Using the induction hob	7
What The Symbols Mean	8
Using The Induction Hob	9
Cookware for Induction Hobs	13
Care of Pans	14
Cooking on Induction Hobs	15
Cooking tips	16
Care & Cleaning	17
Troubleshooting	19
Installation	20
Service Record	26
Technical Data	27

Before Using Your Hob

Thank you for purchasing a new Belling Induction Hob. Its stylish and practical design will enhance your kitchen and make cooking a pleasure. Even if you have used an induction hob before, it is important that you read these instructions thoroughly before starting to cook, paying particular attention to the installation and safety instructions.

If you have any problems with any aspect of your Belling hob, please check through these instructions thoroughly to make sure that you have not missed anything. If you still need help, then please contact us using the customer care centre number at the back of this book.



This appliance is for use in a domestic kitchen only, it is not designed, or intended, for commercial use.



Please keep these instructions in a safe place. Should you sell or pass on the appliance, please give the new owner this handbook.



Before using this appliance please make sure that you have removed all packaging and wrapping. Also remove stickers & film from the ceramic glass.



Although every care has been taken to ensure this appliance has no burrs, or sharp edges, we recommend that you wear protective gloves when installing and moving this appliance. This will prevent any injury.

Our policy is one of constant development and improvement. Strict accuracy of illustrations and specifications cannot be guaranteed. Modification to design and material may be necessary subsequent to publication.



Always use a registered installer for this appliance.
WARNING! For your own safety, make sure that these instructions on installation, use and maintenance are followed.

Environmental protection:



Glen Dimplex Home Appliance brands are committed to protecting the environment and operates an Environmental Management System which complies with BS EN ISO 14001.



All packaging with this appliance is recyclable and environmentally friendly.

Please recycle whenever possible - contact your local authority for your nearest recycling centre.

Safety

Keep children away from the vicinity of the hob when you are cooking.

- Use pans with a flat base which are stable in use, and avoid using any old misshapen pans or any pan which is unstable when placed on a flat surface.
- Never leave fat or oil unattended on an active cook zone. Don't leave pans on the hob when you are not around - remove them or turn the cook zones off (even if only for a moment)
- This appliance is not intended for use by persons (including children) with reduced physical, sensory or mental capabilities, or lack of experience and knowledge, unless they have been given supervision or instruction concerning use of the appliance by a person responsible for their safety.
- Children should be supervised to ensure that they do not play with the appliance
- Keep all flammable materials away from the hob. Ensure electrical leads do not trail over or go near the hob.
- Do not place aluminium foil or plastic utensils on hot surfaces.
- Turn pan handles to a safe position, so they are out of reach of children, not overhanging the appliance and cannot be caught accidentally.
- Commercial simmering aids should not be used as they create excessive temperatures that can damage the surface and may cause a hazard.
- Caution: Do not use the hob if the glass is cracked, as electrical parts are directly beneath. To avoid the possibility of electric shock, turn off the electricity supply to the hob at the socket and arrange a Service call.

WARNING: If you use a griddle plate, ensure that it is completely cool before attempting to lift it from the hob as residual heat may cause burns. Always use oven gloves to protect your hands.

Do not allow yourself to be distracted whilst cooking.

When you have finished cooking check that all controls are in the off position.

Safety Advice

Smoke alarm - buy a smoke alarm fitted with a 'hush button' which can silence the alarm instantly should it activate accidentally & does not necessitate the removal of the battery (except to change for a new one).

Fire Blanket - consider having a fire blanket in your kitchen, mounted on the wall where you can get to it easily & quickly.

Deep-fat Frying - never fill a chip pan (or other deep-fat fryer) more than one-third full of oil. If you do have a chip pan fire:

- 1) call 999 immediately
- 2) never move the pan
- 3) turn off the heat but only if it is safe to do so
- 4) never use water on a chip pan fire as this will create a fireball.

Kitchen Fire - if you have a fire in the kitchen, do not take risks - get everybody out of the house & call 999.

If a pan catches fire:

- 1) do not move it - it is likely to be very hot
- 2) turn off the heat but only if safe to do so & never lean over a pan to reach the controls
- 3) if you have a fire blanket, put it over the pan
- 4) do not use a fire extinguisher on a pan of oil - the force of the extinguisher can spread the fire
- 5) if you have managed to extinguish the fire, allow the pan to cool completely.

Electrical Fire - if you have an electrical fire in the kitchen, do not take risks - get everybody out of the house & call 999 :

- 1) pull the plug out or switch off the power at the fuse box - this may be enough to extinguish the fire immediately
- 2) smother the fire with a fire blanket or use a dry powder or carbon dioxide extinguisher
- 3) remember: never use water on an electrical fire.

Safety & Induction

Detection of an object or a pan on the heating zone

A small object - such as a fork, a spoon or even a ring - placed on a hob cooking zone on its own is not detected as a pan.

The security system acts in the same way when it detects a pan which is not suitable for use on an induction hob.

If you are fitted with a pacemaker or an active implant

The functions of the hob comply with the applicable standards on electromagnetic interference

Your induction cooking hob thus complies fully with the statutory requirements (Directive 89/336/EEC). It is designed to not interfere with the functioning of other electrical equipment as long as these also comply with the same regulations.

Your induction hob generates magnetic fields in its immediate vicinity.

So that there is no interference between your cooking hob and a pacemaker, the pacemaker must be designed in compliance with the appropriate regulations.

In this respect we can only guarantee the compliance of our own product. You can ask the manufacturer or your doctor about the compliance or any incompatibilities of your pacemaker.

USING THE INDUCTION HOB

About the induction hob

The induction hob provides the most energy efficient hob technology available.

The induction system provides superior heat up and cool down times for pans - you get fast, precise, repeatable power control.







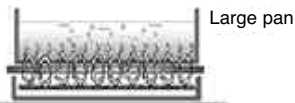
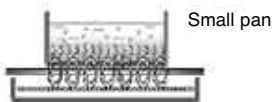

As induction only heats up the pan, there is no lost heat from the cooking process, which in turn, limits the heat generated in the kitchen.

Auto Power Tuning

Induction hobs have a unique power tuning systems that automatically tunes the power to the size of the pan base this ensures energy isn't wasted.



INDUCTION HOB FUNCTIONS

Feature	Symbol	Description
Eco Power		Induction Power is the most energy efficient means of cooking food on a hob, provides fast heat up and boiling times
Rotary Controls		Simple knob control with all the benefits of induction technology
Digital Display		Secret till "lit" hob display
No. of power levels	11	Precise and repeatable control settings
Keep Warm/ Low Temperature		Holds the pan temperature at approximately, ideal for melting chocolate "mmm choc-ol-ateee"
Auto Heat Up (4 Zones)		Automatically heats up and turns down the power to a lower setting. Helps to take the worry out of pans boiling over and burning food
Power Boost		temporarily boost the power to a cook zone by a massive 60%
Pan detection		Lets you know if the correct pans are being used and helps to save energy. When a pan is lifted off the zone, the power is automatically cut.
Overheat pan detection	Yes	Helps prevent cookware from overheating providing an additional level of safety not available on other types of hobs
Child lock	L	Prevents unintentional operation of the hob
Residual heat indicators		Warns you against hot surfaces but also indicates that there is residual heat which can be used as a temporary warm zone
Holiday shutdown	Yes	Rest assured this hob will eventually turn it self off if left
Flush fitting or surface mount	Yes	

USING THE INDUCTION HOB

Induction controls:

To turn the hob 'ON' / 'OFF'

To turn the hob 'ON', turn the control knob for the required cook zone clockwise to set the cook zone to the desired power setting (1 to 9). The power display will automatically light up.

To turn the hob 'OFF' turn the control knob anti-clockwise to the 'OFF' position.

Auto Heat Up

Helps to take the worry out of pans boiling over and burning food! No need to stand over the pan, allows you to do other tasks whilst maintaining control over the pan.

The Auto Heat Up is activated by rotating the control knob anti-clockwise and holding for a couple of seconds until the  symbol lights up in the display area, then by rotating the control knob to the required turn down setting.

The Auto Heat Up delivers full power (9) to the zone for a fixed period of time before automatically turning back down to the desired setting.

The Auto Heat Up has been tuned to provide the best boost period for each setting.

Average Auto Heat up time is 3 minutes.

Power Setting	Suggested food type	Auto Heat Up time (mins)
Low temp U °C	Melting chocolate	n/a
1	Milk, Soup Stews, Vegetables	1
2		2.5
3		4
4	Rice, Potatoes, Pasta	5
5		7
6	Frying, fish fingers Pancakes, Steaks	2
7		3
8		4
9	Full power	n/a
Boost	Full power +60%	n/a

USING THE INDUCTION HOB

Power Boost *P*

Rev up your hob with this feature, temporarily boost the power to a cook zone by a massive 60%.

The power boost is a function that can be used to temporarily boost the normal maximum power for a cook zone by borrowing the available power from a "paired zone".

The Power Boost is activated by rotating the control knob clockwise past power setting 9 and holding for a couple of seconds until *P* lights up in the display area. Power Boost is now activated.

The hob is split into "two paired areas".

LH Area (LHF and LHR Cook Zone) and RH Area (RHF and RHR Cook Zone).

Only one cook zone per area can be boosted at anyone time.

Note The Power Boost function will only operate for a limited time and is also under thermal control. This means the power boost will deactivate automatically if the product is hot, to protect the internal electronic components of the hob and to prevent the cookware from overheating.

Cook Zone	Normal Max Power	Boosted Power kW	Maximum Permissible setting on paired zone
LHF	1.40	2.20	9 (LHR)
LHR	1.85	3.00	8 (LHF)
RHF	1.40	2.20	8 (RHR)
RHR	2.30	3.70	6 (RHF)

USING THE INDUCTION HOB

Keep Warm

The Keep Warm setting is found between power setting 0 and 1. Rotate the control knob clockwise until the  symbol appears on the display.

Pan detection

When a zone has been activated but no pan has been placed on the cook zone, this means the hob only uses power when a suitable pan is placed on the zone, this reduces the energy used during the cooking process, i.e. when you take your pan off the zone the hob automatically reduces the power, and only switches back on when you replace the pan.

Note If the  symbol does not disappear when a pan is placed on the zone it indicates that the pan is not suitable for induction cooking.

Get a magnet to check the pans.

Pan Sizes

Cook Zone	Smallest recommended pan diameter
LHF	120 mm
LHR	145 mm
RHF	120 mm
RHR	180 mm

Overheat pan protection

The hob is equipped with additional safety systems that help to prevent cookware from overheating, providing an additional level of safety not available on conventional hobs such as gas and ceramic hobs.

Approx Glass Surface Temp. degC	Intelligent hob safety system
200	Reduces Power Boost setting to Power Level 9
250	Reduces power to 60% of Power Level setting
270	Switches cook zone off
300	Switches whole appliance off

Note

The safety temperature control of the pans is only possible with quality flat bottomed pans suitable for induction cooking; Poor quality pans can create air gaps between the glass and the pan, which affects the accuracy of the temperature control.

Auto Stand-by (holiday shutdown)

Have you ever gone holiday & wondered if you have switched the hob off?

No need to worry about leaving your hob on - with the most advanced cooking system available, the hob will automatically switch itself off if left unattended.

USING THE INDUCTION HOB

Child Lock **L**

Stops the “kids” messing with your lovely induction hob.

This feature is to help prevent accidental switching on of the hob, especially by young children.

To activate/deactivate, simultaneously rotate the Left Hand Rear and Right Hand Rear control knobs to the Auto Heat Up setting ‘A’ for a couple of seconds. **L** will light up in the display area for all cook zones to show activation. Follow the same procedure to deactivate and the **L** symbol will disappear from the display area.

Residual Heat indicators **H**

If when the cook zone is switched off the glass surface is above 60°C, **H** will be displayed in the cook zone display until the glass surface drops below approx 55°C.

This feature not only warns you against hot surfaces but also indicates that there is residual heat which can be used as temporary warm zone.

Note - The cook zone itself does not heat up, but the ceramic glass does get hot because of the hot pan conducting heat back onto the hob glass.

USING THE INDUCTION HOB

Cookware for induction hobs

Cookware for induction cooking zones must be made of metal and have magnetic properties. The base must also be the correct diameter.

Suitable Cookware for Induction Hobs	Unsuitable Cookware
Enameled steel pots with a thick base	Pots made of copper, stainless steel, aluminium, oven-proof glass, wood ceramic and terracotta
Cast Iron pots with an enameled base	
Pots made of multilayer stainless steel, rustproof ferrite steel or aluminium with a special base	
Pans marked for use with induction	

How to establish the suitability of a pan

Check your pans with a magnet. If it sticks and it's the correct diameter, it's suitable for use with induction. Also with pans that bear the symbol for suitability for cooking with induction.

Note - when using certain pans, you may get various noises from the pans. This is due to the design of the pans and does not effect the performance or safety of the hob.

Care Of Pans

Looking after your pans

Stainless steel pans

Stainless steel pans should be cleaned with a soft cloth and soapy water.

Appearance of white marks:

Cause: salt added to cold water.

Solution: add salt when the water boils.

Appearance of specks:

Cause: hard water.

Solution: boil diluted vinegar in the pan, then rinse and dry.

Burned food stuck to the bottom of the pan:

Cause: temperature too high.

Solution: leave the pan to soak, or boil soapy water in it (1 part washing-up liquid to 10 parts of water).

Cast iron pans

Cast iron pans should only be cleaned with a sponge or nylon brush or a non-abrasive washing-up product.

Wipe with a little vinegar to regain the pan's shine.

This also works for colour-enamelled cast iron. For "matt black" items, use vinegar instead of bleach, then oil carefully and wipe with kitchen roll.

Cooking On Induction Hobs

- Do not leave an empty pan on a heating zone.
- Pans should be placed in the centre of the heating zone.
- Never heat up a sealed tin of food, as it may explode.
- When you use a pan with a non-stick coating (eg; Teflon) with little or no fat, heat the pan first for a moment on setting **6** or **7**.
- We recommend that you do not put metal cooking utensils, cutlery, knives or other metal objects on the hob, as they could become hot if they are near a cooking area which is in use.
- It is perfectly possible to use a pan with a smaller diameter than that of the ring marked on the vitro-ceramic glass; there will be no loss of energy as is the case with conventional cookers (electricity and gas).
- Nothing should ever be left lying on the hob.
- Lift pans onto and off the hob, rather than sliding them across the surface, to avoid marks and scratches.
- As soon as the water boils, turn the cooking zones down to a lower setting; this will help prevent pans boiling over.
- As pans are on a smooth surface, they will move easily if knocked accidentally; turning pan handles so they are not overhanging the edge of the hob, will help prevent this happening and keep them out of the reach of children.
- Be careful when cooking foods in salted water, or foods containing large amounts of sugar or syrup, if they are spilt onto hot areas of the hob they may damage the glass.

Wipe any spillage as soon as possible.

Use pans which are large enough to avoid overflows onto the vitro-ceramic glass hob surface.



Do not use the hotplate surface for storage, as a chopping board or work surface. This may damage the glass or cause it to shatter without warning due to small chips in the glass.



Always switch off the appliance after use. Do not use the pan detector (if fitted) as a method of switching off the appliance.

Cooking Tips

- Green vegetables (spinach, broccoli, sorrel, etc) or vegetables rich in sulphur compounds (cabbage, onions, etc) should be cooked without a lid in plenty of boiling water; they will cook more quickly, and will keep their green colour (some vegetables only), vitamin and minerals content.
- Pasta, rice, cereals, etc absorb water during cooking and increase in volume; cook them in plenty of boiling salted water in order to dilute the starch they contain.
- Make sure you use a sufficiently large pan to avoid boiling over; the temperature setting may need to be reduced to maintain a simmer.
- Mushrooms should be poached in a small quantity of boiling water, with salt, butter and lemon juice.
- When liquids boil, reduce the control setting to maintain a simmer.
- Vegetables will cook quicker if chopped in smaller pieces.

Aluminium foil

When cooking, never use kitchen foil and never put items wrapped in kitchen foil straight onto the hob.

The aluminium kitchen foil may melt and do irreparable damage to your appliance.

Care & Cleaning

Some cooking operations generate a considerable amount of grease. This, combined with spillage, can become a hazard if allowed to accumulate on the hob through lack of cleaning. In extreme cases this may amount to misuse of the appliance and could invalidate your guarantee.

Do not use caustic pastes, abrasive cleaning powders, coarse wire wool or any hard implements, as they will damage the surfaces.

Do not use soap filled pads, metal wire, bleaches, bath stain removers, or chemical oven cleaners; all these product types will damage the ceramic glass.

All parts of the hob can be safely cleaned with a cloth wrung out in hot soapy water.

The following recommendations will help to keep the ceramic glass surface bright and clean:

- Use a dampened paper towel or clean damp cloth to apply a small dab of cleaner conditioner to clean each heating area.
- Use another paper towel or a clean dry soft cloth to wipe dry, and then polish the whole glass surface.
- To remove any stubborn marks or heavy soiling, a non scratching, mild cream cleaner may be used. Alternatively, a "ceramic hob scraper" may be used.

Important: If you use a wet paper towel or clean damp cloth to remove spillage from a warm heating area of the hob, be careful to avoid steam burns.



Always **allow the hob to cool before cleaning.**

Always: **switch off the electricity supply before cleaning this appliance.**

Caution: **Any cleaning agent used incorrectly may damage the hob.**



Do not use steam cleaners on any part of this appliance.

Care & Cleaning

Care and maintenance

Before using the hob for the first time, apply a thin coating of cleaner conditioner to the ceramic glass, and polish the surface with a clean cloth.

The conditioner gives a protective covering to the ceramic glass which not only makes the hob easier to clean, but also ensures that you will gain maximum life out of this product. Occasional use will help prevent the build up of mineral deposits which can cause discolouration of the hob surface.

Discolouration of the hob

Do not use a dishcloth or dish sponge to wipe the hob - this can leave a film of detergent on the surface which will discolour the hob next time a heating area is used. Clean cloths kept for the cleaning of the hob can be used.

Do not use too much cleaner conditioner - only a thin coating is required, any excess may burn on and discolour the hob when it is next in use.

If persistent stains or marks remain on the ceramic glass surface, it can be cleaned using a mild cream cleaner or a ceramic hob scraper. This will also remove any accumulated salts or minerals before they have an opportunity to discolour the ceramic glass.

Wipe clean with a damp paper towel or clean damp cloth and re-apply cleaner conditioner.

	Remove spillages	
Type of spillage	Immediately	Wait for the appliance to cool down - "Burn Risk"
Water, milk, sauces	Y	
Sugar & food containing sugar	Y	
Residue from frying		Y
Fat splashes		Y

Troubleshooting

The hob produces a smell the first few times it is used

- Heat a pan full of water on each zone for half an hour.

Pans make a noise during cooking!!

- This is caused by vibration due to the passage of energy from the hob to the pan. On a high setting this is quite normal for certain types of saucepan. It will not damage the hob.

The hob makes a slight clicking sound

- This is caused by the distribution of power between two heating zones on the same side of the hob.

The top of the hob is always warm (even when not in use)

- The electronic part of the hob, like any other electronic equipment (TV, transformer, etc), becomes warm.

The fan keeps working for a few minutes after the hob has been turned off

- To cool down the electronics.

The hob won't work. The indicators don't come on

- The electricity supply is not reaching the appliance (faulty supply or connection); Check the fuses and the cut-out switch.
- The electronic circuit is not working properly; Call Stoves Customer Support, or your supplier.

When it is turned on, the appliance cuts out

- The hob connection is faulty.

Check the connection and check that the connection complies with the appropriate standards.

Code	Problem	Possible Cause	Solution
	Hob is not working (L) in display	Child lock is activated	Deactivate child lock
	Power boost not working	The appliance is hot - Power Boost is deactivated when the appliance is hot to protect the electronics & prevent pans overheating	Allow appliance to cool, power boost will be available when the appliance is cool
ER21	Control unit cuts off after programme setting	Electronics overheating	Allow appliance to cool
ER400			Check mains cable connection & terminals at the terminal block are wired correctly
E2	Overheating of induction coil	Pan overheating	Remove pans & allow to cool
E8	Fan blocked or faulty	Fan inlets are blocked or faulty fans	Clean fan inlet at rear/underside of the appliance

Installation Instructions

General information

Installation should only be carried out by a qualified installer or engineer.

Please keep to the following points most carefully;

- The hob should not be fitted above a washing machine, a fridge or a freezer.
- Wall surfaces above the work surface and in the immediate vicinity of the cooking hob must be heat resistant.
- Laminated surfaces and the adhesive used for fixing them must be heat resistant in order to avoid any damage.
- The space for air circulation, located underneath and at the back of the hob improves its reliability by ensuring that it will cool down, efficiently.
- For installations in the Republic of Ireland, refer to National Regulations applicable to this product.



We recommend that you install this appliance in a work top which is a minimum 38mm deep. The hob can be fitted into a work top less than 38mm deep, but the 9mm gap between hob base and appliance must be maintained.

Choosing your installation

1. Over a unit with a door or drawer.
2. Above an oven.

Induction hob

Make sure that the air inlets through the ventilator grids underneath the hob are never blocked.

Installing the hob over a unit with a drawer or door

Air outlet is underneath work surface.

If necessary, remove the front crosspiece of the unit.

Suitable protection to prevent obstruction of the air inlet to the fans must be provided.

Installation Instructions

Installation advice - cabinetry

Dealing with sides, cross-rails and back-panels in cabinetry

Depending on the cabinets, the worktop thickness and the hob positioning, it is possible for the hob base and/or the clamp brackets to interfere with parts of the cabinet. These can be dealt with as follows:

Cabinet sides

If the hob is to be installed across the top of two cabinet housing units, then the base of the hob may interfere with the sides of these units. It will be necessary to cut away the top of the unit sides locally to clear the hob and/or the clamp brackets.

Cross-rails

1. Interference with hob base

If there are any cross-rails which obstruct the hob base by running across the worktop cutout, they can simply be removed or locally cut-away to allow the hob to be installed, depending on the particular installation. Any modifications must ensure that the strength of the cabinet is maintained.

2. Interference with clamp brackets

If there are any cross-rails which prevent the clamps from being positioned on the front or rear edges of the hob, then they can be removed or locally cut-away around the brackets to allow the brackets to be installed. Any modifications must ensure that the strength of the cabinet is maintained.

Back-panel

If the cabinet has a back-panel which prevents the clamps from being positioned on the rear edge of the hob, then this panel can be completely removed or locally cut-away to allow the brackets to be installed.

Installation Instructions

Installation above an oven

Refer to the manufacturer's instructions for clearances above the oven.

We recommend a 9mm gap between the bottom of the hob and appliance, should the work surface be less than 38mm deep.

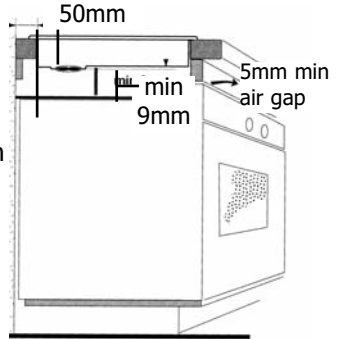

In the case of a pyrolytic oven

If installing the hob above a pyrolytic oven, additional provision for air circulation / ventilation may be required. Due to the excessive temperatures attained during pyrolysis, using the hob at the same time may cause the thermal safety device within the hob to operate.

Clearances and dimensions - requirements

1. No shelf or overhang of combustible material should be closer than 650mm above the hob.
2. There must be a minimum clearance of 50mm between the edges of the hob and any side walls; this clearance must be maintained up to 420mm above the worktop.
3. There must be a minimum clearance of 50mm between the rear edge of the hob and the rear wall. This clearance must be maintained up to 650mm above the worktop.
4. When installing an extractor hood above the hob, refer to their Manufacturer's instructions.

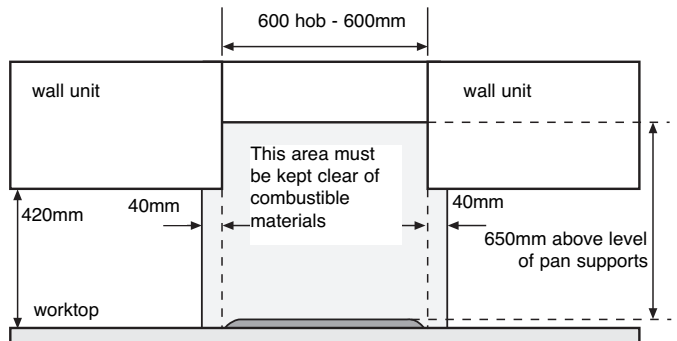
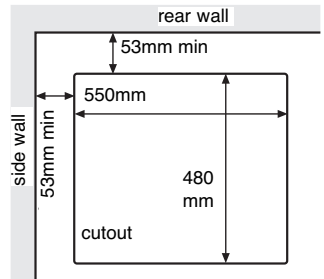

Installation Instructions

Fitting into worktop

- Cut a hole in the work surface to the required size. See table for relevant dimensions.
A clearance of at least 50mm should be maintained between the cutout and any rear or side wall.
- The worktop must be of heat-resistant material or covered with heat-resistant material.
- Protecting the cut-out;
The types of chipboard used for work surfaces swell relatively quickly in contact with humidity.
Apply a special varnish or adhesive to the cut edge to protect it from steam or condensation which may form under the work surface under the hob.

Cutout required	
WIDTH	550mm
DEPTH	480mm
Clearance required	
SIDE WALL	53mm
REAR WALL	53mm

This hob can be installed conventionally (glass above the work top) or recessed into the work top for a flush fit.

Conventional Installation

Apply the self adhesive seal to the underside edges of the hob glass. For best results, the seal should be adhered along each side in turn, as close to the edge as possible, and trimmed at each corner, taking care to ensure a neat join.

Place the hob in the aperture, checking the hob glass is covering the work top along all four sides. Set the front edge of the appliance parallel with the front of the work top. Locate and attach the securing clamps to the front and rear underside of the hob, using the 2-off pozidriv self-tapping screws provided. Tighten the screws so that the hob is pulled down firmly against the worktop, thus ensuring a good seal.

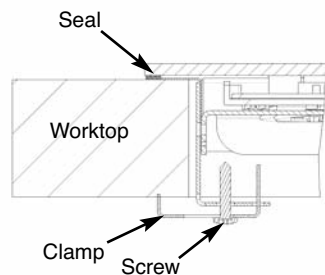

Important: Clamps may be reversed to fit either 30mm or 40mm deep work top.

Installation Instructions

Recessed Method (selected models)

Recess the work top to the appropriate depth and shape to fit the hob.

Apply the self adhesive seal to the underside of the hob glass. For best results, the seal should be adhered along each joint in turn, as close to the edge as possible, and trimmed at each corner, taking care to ensure a neat join.

Insert the hob into the recess, ensuring that the foam seal is sitting correctly. Locate and attach the securing clamps to the front and rear underside of the hob, using the screws provided. Tighten the screws so that the hob is pulled down firmly against the worktop, thus ensuring a good seal.

You may want to fill any gap between the hob top glass and the work top surface with silicone sealant. **DO NOT** fit silicone sealant under the glass hob instead of foam seal.

i Important: Clamps may be reversed to fit either 30mm or 40mm deep work top.

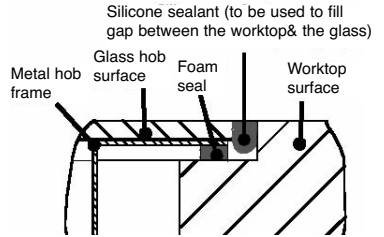

Installation Instructions

Connect to the electricity supply

Warning: This appliance must be earthed.

The hob must be installed by a competent electrician, using a suitable double pole control unit, with 3mm minimum contact separation at all poles.

We recommend that the appliance is connected by a qualified electrician who will comply with the I.E.E. and local regulations.

- Connection should be made with a suitable cable.
- Strip the wires & connect to the terminal block as shown in the diagram & table below.
- Fit the cable clamp & secure with the torx head screw provided.
- Close the terminal box, ensuring that the cover is engaged on the locking tabs.

i Important: Ensure that you route all mains electrical cables well clear of any adjacent heat source, such as an oven or grill.

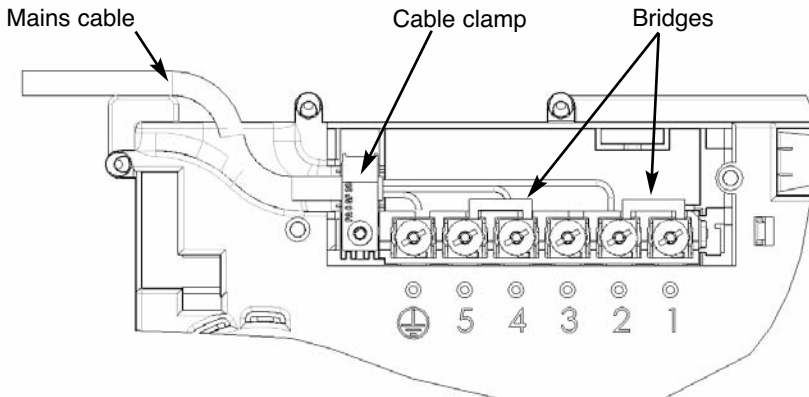

Wire	Colour	Connect to:
Live	Brown	Terminal 2
Neutral	Blue	Terminal 4
Earth	Yellow / Green	

Service Record

Model Number									
Serial Number									

Date of purchase	Installer stamp / Printed name	Date of installation
Place of purchase:		

Date	Part(s) replaced	Engineers Stamp/ Printed Name

Should you need to contact us, please call our Customer Care Centre on:

0844 815 3746

Calls will be answered in strict rotation, as soon as possible.

Please record your model and serial number in the spaces above.

Having these numbers to hand will help us to help you quickly and more efficiently should you need to call us for any reason.

Technical Data

Electrical supply/load 220-240V 50Hz 7.0kW

Countries of Destination:

GB = Great Britain, IE = Ireland

Warning: This appliance must be earthed.

Data badge is located on the underside of the hob.

Stoney Lane, Prescott, Merseyside, L35 2XW

08 27443 00 © 09.2009