

Users Guide & Installation Handbook



Belling 60 - 70 - 90cm
Hob Rotary UK

belling[®]
think of everything

Part No 082756703 Date 19/03/2013

CONTENTS & INTRODUCTION

CONTENTS

- SAFETY
- USING THE PRODUCT
- CLEANING
- INSTALLATION INSTRUCTIONS
- TECHNICAL DATA
- CUSTOMER CARE

INTRODUCTION

Thank you for buying this British-built appliance from us.

This guide book is designed to help you through each step of owning your new appliance, from installation to use. Please read it carefully before you start using your product, as we have endeavored to answer as many questions as possible, and provide you with as much support as we can.

If, however, you should find something missing, or not covered, please contact our Customer Care team. Their number is located on the back page of this book.

For customers outside the UK and Northern Ireland, please contact your local supplier.

When you dial this number you will hear a recorded message and be given a number of options. This indicates that your call has been accepted and is being held in a queue. Calls are answered in strict rotation as our Customer care representatives become available.

Alternatively, general information, spares and service information is available from our website. The address is located on the back page of this book.

WARRANTY

Your new appliance comes with our 12-month guarantee, protecting you against electrical and mechanical breakdown. To register your appliance please call **0844 481 0182**, complete the registration form included or register online at the web address located on the back page of this book.

For full terms & conditions of the manufacturer's guarantee, refer to the website on the back of this book.

Our policy is one of constant development and improvement, therefore we cannot guarantee the strict accuracy of all of our illustrations and specifications - changes may have been made subsequent to publishing.

WARRANTY EXCLUSIONS

Damage or calls resulting from transportation, improper use or the replacement of removable parts.

Costs incurred for calls to put right an appliance which is improperly installed.

Appliances found to be in use within a commercial environment, plus those which are subject to rental agreements.

Before using the hob

Make sure that you have removed all packaging, wrappings, stickers and films from the hob surface.

It is recommended that you clean and wash the hob surface before using for the first time.

Apply a thin coat of ceramic hob cleaner to the hob to help maintain and protect it.

See the customer care section for details of how to obtain all the available cleaning products.

SAFETY

BEFORE USING THE PRODUCT

Make sure that you have removed all packaging and wrapping. Some of the items inside this appliance may have additional wrapping.

GENERAL

WARNING! - The appliance and its accessible parts become hot during use. Care should be taken to avoid touching heating elements. Children less than 8 years of age shall be kept away unless continuously supervised. This appliance can be used by children aged from 8 years and above and persons with reduced physical sensory or mental capabilities or lack of experience and knowledge if they have been given supervision or instruction concerning the use of the appliance in a safe way and understand the hazards involved. Children shall not play with the

appliance. Cleaning and user maintenance shall not be made by children without supervision.

WARNING! -

Unattended cooking on a hob with fat or oil can be dangerous and may result in fire.

NEVER try to extinguish a fire with water, but switch off the appliance and then cover the flame with a lid or damp cloth.

WARNING! - Danger of fire: Do not store items on the cooking surfaces. Never leave any cook zone on without a pan covering it. This causes a fire hazard.

WARNING! - Servicing should be carried out only by authorised personnel.

WARNING! - The appliance must never be disconnected from the mains supply

SAFETY

during use, as this will seriously affect the safety and performance, particularly in relation to surface temperatures becoming hot and gas operated parts not working efficiently. The cooling fan (if fitted) is designed to run on after the control knob has been switched off.

WARNING! -

Do not spray aerosols in the vicinity of this appliance while it is in operation.

WARNING! - Do not store or use flammable liquids or items in the vicinity of this appliance.

WARNING! -

Do not modify this appliance.

WARNING! - Do not operate the appliance without the glass panel

correctly fitted.

WARNING! - There is a risk of electric shock, so always make sure you have turned off and unplugged your appliance before starting. Always allow the product to cool down before you change a bulb.

WARNING! - Do not modify the outer panels of this appliance in any way.

WARNING! - This appliance must be earthed.

WARNING! - The top element gets extremely hot when in use, so take care to avoid touching it.

GAS WARNING! -

If you smell gas:

Do not try to light any appliance.

Do not touch any

SAFETY

electrical switch.
Contact your local gas supplier immediately.

ELECTRIC INDUCTION HOB

WARNING:-

Unattended cooking on a hob can be dangerous and may result in fire. NEVER try to extinguish a fire with water, but switch off the appliance and then cover flame e.g. with a lid or a damp cloth.

Danger of fire: do not store items on the cooking surface.

If the surface is cracked, broken or shattered, switch off the appliance to avoid the possibility of electric shock and call for a service engineer's visit.

Metallic objects such as knives, forks, spoons and lids should not be placed

on the hob surface since they can get hot.

Ensure you switch off the appropriate cook zone individually or (by the central on/off key if touch control) when you have finished cooking, do not rely upon the automatic pan detection system as your means of switching "off" the appliance.

This induction hob complies with the applicable EMC and EMF standards. Therefore it should not interfere with other electronic units. Persons fitted with a pacemaker or any other electrical implant should clarify with their doctor or the producer of the implant, whether there implant is adequate and

fail-safe.

The pacemaker must be designed in compliance with the appropriate regulations.

Caution: This appliance is for cooking purposes only. It must not be used for other purposes, for example room heating.

Caution: The use of a gas cooking appliance results in the production of heat, moisture and products of combustion in the room in which it is installed. Ensure that the kitchen is well ventilated especially when the appliance is in use. Keep natural ventilation holes open or install a mechanical ventilation device (mechanical extractor hood).

Prolonged intensive use of the appliance may call for additional ventilation, for example opening of a window, or more effective ventilation, for example increasing the level of mechanical ventilation where present.

Induction Hob

Parts of the appliance may become hot while in use. Always make sure that children are supervised when they are near to the appliance.

Always position pans over the centre of the cook zone, and turn the handles to a safe position so they cannot be accidentally knocked or grabbed.

Do not leave pans on

SAFETY

the hob when you're not around - take them off the cook zone if you have to leave the kitchen even if you think it will only be for a moment, while you answer the door or phone.

If you use a griddle plate ensure it is completely cool before attempting to lift it from the hob as residual heat may cause burns, Always use oven gloves to protect your hands.

The appliance has a glass hob top, make sure you do not drag pans across the ceramic surface as this will lead to scratches and damage.

Do not use the hob surface as a chopping board or food preparation area as this may lead to it becoming

damaged.

The glass ceramic can get hot whilst cooking; even though the cook zone itself does not generate heat. The heat generated is conducted back from the hot pans.

Keep electrical leads from trailing over or going near the hob.

The appliance must never be disconnected from the mains supply during use as this will seriously affect the safety and performance, particularly in relation to surface temperatures becoming hot and component parts not working efficiently. The cooling fan (if fitted) is designed to run on after the control has been switched off.

Fire Safety Advice

Most kitchen fires occur when people are

SAFETY

distracted or leave things unattended, so remember:

If you're called away from the cooker - by the phone or someone at the door, either take pans off the heat, or switch off your hob.

Don't let yourself be distracted while cooking.

If you do have a fire in the kitchen, don't take any risks - get everyone out of your home and call the Fire Brigade.

Unattended cooking on a hob with fat or oil can be dangerous and may result in a fire. NEVER try to extinguish a fire with water, but switch off the appliance and then cover flame e.g. with a lid or a fire blanket.

WARNING - If a pan catches fire:

- Do not move it - it is likely to be extremely hot
- Turn off the heat if it's safe to do so - but never lean over a pan to reach the controls.
- If you have a fire blanket, put it over the pan.
- If you have put the fire out, leave the pan to cool completely.

Deep-fat frying presents more dangers in your kitchen.

- Never fill a chip pan (or other deep-fat fryer) more than one-third full of oil
- Do not use a fire extinguisher on a pan of oil - the force of the extinguisher can spread the fire and create a fireball.

If you have an electrical fire in the kitchen:

- Pull the plug out, or switch off the power at the fuse box - this may be enough to stop the fire immediately
- Smother the fire with a fire blanket, or use a dry powder or carbon dioxide extinguisher

- Never use water on an electrical or cooking oil fire.

DISPOSAL

Packaging Material

The packaging materials used with this appliance can be recycled.

Please dispose of the packaging materials in the appropriate container at your local waste disposal facilities.

Old Appliances



The Symbol  on the product or on its packaging indicates that this product may not be treated as household waste. Instead it should be taken to the applicable collection point for the recycling of electrical and electronic equipment.

You will by ensuring the appliance is correctly disposed of help prevent potential negative consequences for the environment and human health.

For additional details regarding the recycling of this product please contact your local government office, your household waste disposal service or the retailer where you purchased the product.

USING THE HOB - ELECTRIC (CERAMIC)

Using Rotary Controls

- Select the cooking zone you wish to use.
- Place a suitable pan within the designated cooking zone.
- Turn the assigned control knob to the power setting you wish to use.
- Power setting 1 is the lowest and 6 is the highest.
- To switch off, turn the selected control knob to the 'off' position.

Note:

- The power settings on the hob do not indicate any set temperature and cannot be used to judge one element against another.
- During cooking, the cook zone elements will cycle on and off. This provides the correct power setting and prevents the hob from overheating.

WARNING! - Risk of burns from residual heat!

- The glass surface of the hob gets extremely hot during and after use, under no circumstances allow any person and especially children to touch, sit or stand on the hob glass surface.
- Allow the hob to fully cool, which can take approx 30 mins before the hob is safe to touch e.g. for cleaning.

Hot Hob Warning (if fitted)

- Some appliances have a hob hot light fitted to provide an additional visual warning regarding the temperature of the glass surface.
- If your appliance has this feature it will have the word "Hob Hot" written on the glass and a red light will illuminate shortly after you have

switched on a cook zone and remains lit for a while after all the cook zones have been switched off to show that the surface may still be hot to touch.

- You can use the residual heat to save energy, e.g. to keep a small dish warm

Cooking Surface layout

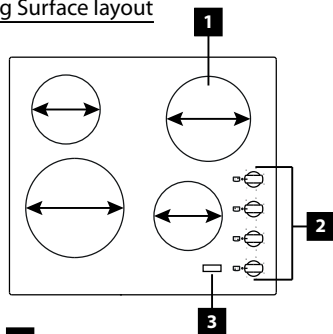

Cooking zone control knob

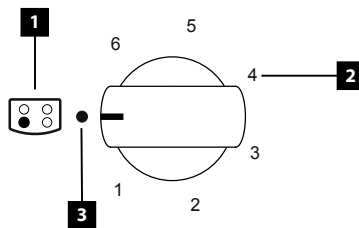

- 1** Assignment of control knobs
- 2** Power setting (0 - 6)
- 3** Off position

Note: Generic illustrations shown above your appliance may visually differ.

CLEANING

ELECTRIC HOB

Ceramic glass hobs

- It is recommended that you clean and wash the hob surface before using for the first time. Apply a thin coat of ceramic hob cleaner to the hob to help maintain and protect it.
- The ceramic hob top can be cleaned using a clean, damp cloth or kitchen paper. Do not use a used dishcloth or sponge as they can leave a film of detergent on the surface which can lead to discoloration. Please ensure that the elements are cooled fully to avoid steam burns.
- You can use a specialist ceramic cleaner to restore the surface, but use sparingly to avoid coating the hob top too thickly. Too much cream cleaner will lead to discolouration. Use a dry, clean cloth to polish the surface.
- For stubborn marks, a specialist hob scraper or cleaner can be used.
- Do not use steam cleaners or high-pressure cleaning equipment.
- Regular cleaning will prevent any salts or minerals from accumulating on your hob and discolouring the glass.
- Wipe any spillage as soon as possible.
- Clean the hob top as regularly as possible, this will prevent any build up of grease which may be a fire hazard.

Solid plate hobs

- Prime and Season - this helps maintain the finish of the elements.
- Use a damp, clean cloth to wipe the solid plate, making sure that you

follow the circular grooves and avoid damaging the red spots. Make sure that you allow the hotplate to dry before use by switching on the elements at a low heat.

- You can restore the hotplates by using a solid plate cleaner but take care to avoid the red spots on elements.
- To prime: Switch on each element in turn for a short while (with no pan on it) at a medium - high setting. This will harden and burn off the coating.
- To season: Heat the element for 30 seconds at a medium setting then switch off. Use a minimum amount of unsalted vegetable oil, on a dry cloth or paper towel, and apply a thin coat of oil to the element surface. Wipe off the excess and heat the element for one minute.

Notes:

- The edge of the ceramic glass will always appear to be a different colour than the top surface due to the ground safety edge.
- Scratches or dark stains on the ceramic glass that cannot be removed do not affect the function of the appliance.

Safety when Cleaning

- For cleaning, the appliance must be switched off and cooled down.

WARNING! Risk of burns from residual heat.

INSTALLATION

General information

Installation should only be carried out by a qualified installer or engineer.

Please keep to the following points most carefully;

Although every care has been taken to ensure this appliance has no burrs, or sharp edges, we recommend that you wear protective gloves when installing and moving this appliance. This will prevent injury.

The minimum distances to other appliances and units are to be observed.

Wall surfaces above the work surface and in the immediate vicinity of the cooking hob must be heat resistant.

Laminated surfaces and the adhesive used for fixing them must be heat resistant in order to avoid any damage.

The space for air circulation, located underneath and at the back of the hob improves its reliability by ensuring that it will cool down, efficiently.

Installations should be carried out in line with the National Regulations applicable with this product type.

Note: Avoid installing the appliance next to doors and under windows. This will avoid the potential for hot cookware being knocked off the hob when doors and windows are opened (Risk of burns).

Built-in appliances may only be used after they have been built-into suitable built-in units and surfaces that meet the required standards.

CHOOSING YOUR INSTALLATION

We recommend that you install this appliance in a work top which is a minimum 38mm deep.

The hob can be fitted into a work top less than 38mm deep, but the 25mm gap

between hob base and appliance must be maintained.

Installation above an oven

Refer to the manufacturer's instructions for clearances above the oven.

We recommend a 25mm gap between the bottom of the hob and appliance.

Installation above a unit with a drawer or door

The base of the appliance must be protected from damage e.g. draws may only be installed providing a partition panel is fitted to the required dimensions underneath the appliance.

INSTALLATION ABOVE AN OVEN

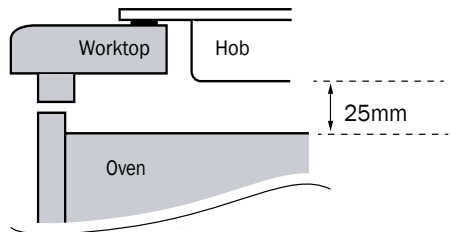

INSTALLATION ABOVE A UNIT WITH A DRAWER OR DOOR

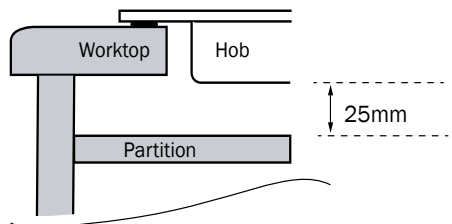

INSTALLATION

Clearances and dimension – requirements

No shelf or overhang of combustible material should be closer than 650mm above the hob.

There must be a minimum clearance of 50mm between the edges of the hob and any side walls; this clearance must be maintained up to 420mm above the worktop.

There must be a minimum clearance of 50mm between the rear edge of the hob and the rear wall. This clearance must be maintained up to 650mm above the worktop.

When installing an extractor hood above the hob, refer to their Manufacturer's instructions.

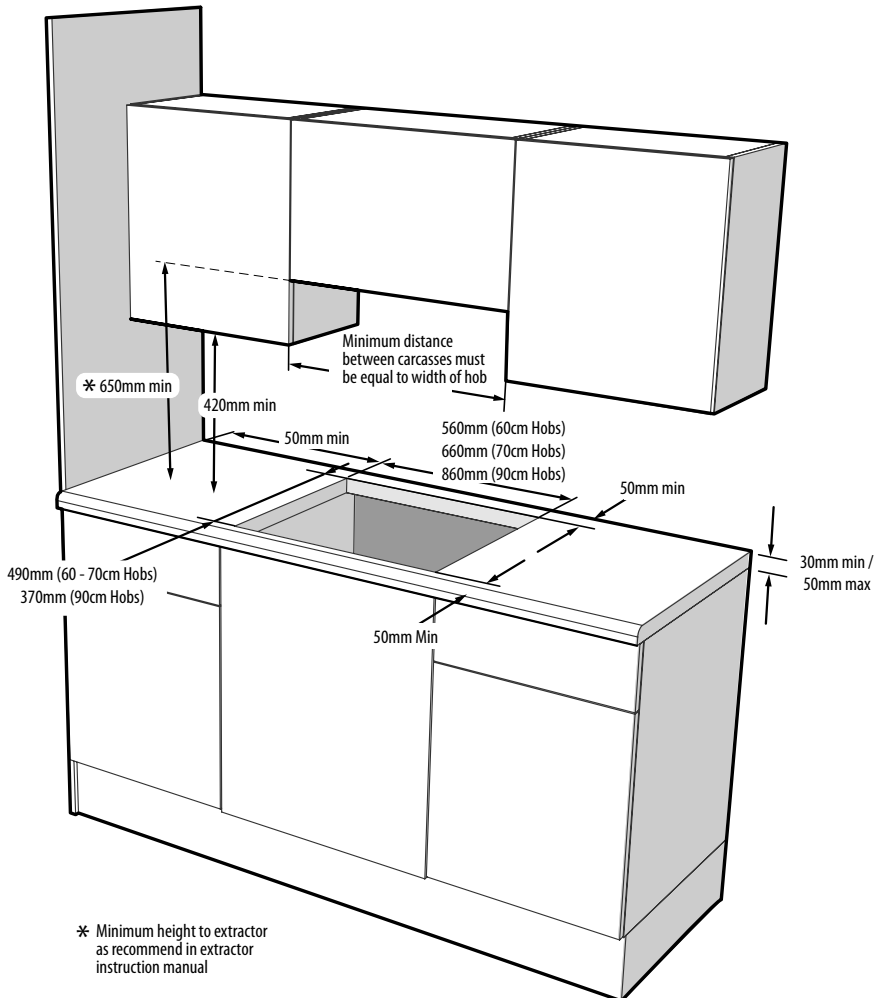

INSTALLATION

Fitting into worktop

Cut a hole in the work surface to the required size. The worktop must be of heat-resistant material or covered with heat-resistant material.

Protecting the cut-out;

The types of chipboard used for work surfaces swell relatively quickly in contact with humidity.

Apply a suitable sealant to the cut edge to protect it from moisture ingress.

This hob can be installed conventionally (glass above the work top) or recessed into the work top for a flush fit.

Self adhesive seal

Apply the self adhesive seal to the underside edges of the hob glass. For best results, the seal should be adhered along each side in turn, as close to the edge as possible, and trimmed at each corner, taking care to ensure a neat join.

UNDERSIDE OF HOB

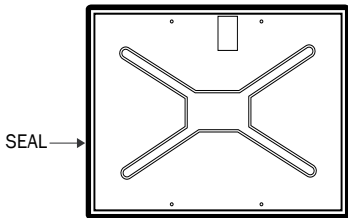

Conventional Installation

Refer to the installation bracket advice to determine your installation type. Place the hob in the aperture, checking the hob glass is covering the work top along all four sides.

Set the front edge of the appliance parallel with the front of the work top. Locate and attach the securing clamps as required, Tighten the screws so that the hob is pulled down firmly against the worktop, thus ensuring a good seal.

Recessed Method

Recess the work top to the appropriate depth (Approx 5mm) and shape to fit the hob (add 1mm to overall glass size). Refer to the installation bracket advice to determine your installation type. Insert the hob into the recess, ensuring that the foam seal is sitting correctly. Locate and attach the securing clamps as required, Tighten the screws so that the hob is pulled down firmly against the worktop, thus ensuring a good seal. You may want to fill any gap between the hob top glass and the work top surface with silicone sealant.

DO NOT fit silicone sealant under the glass hob instead of the self adhesive seal.

CONVENTIONAL INSTALLATION

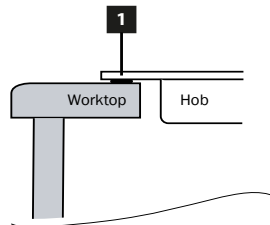

1 SELF ADHESIVE SEAL

RECESSED METHOD

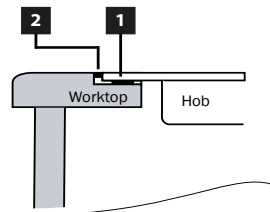

1 SELF ADHESIVE SEAL

2 SILICONE SEALANT

INSTALLATION

Installation Bracket Advice

Secure the hob to the worktop by means of the brackets provided, taking the thickness of the worktop into account.

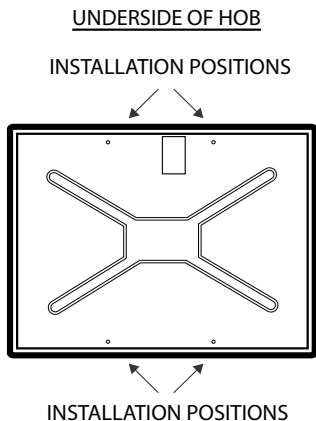

Depending on your appliance it will be supplied with one of the following installation packs;

Installation pack 1

4 x "U" shape installation brackets
4 x Spire clips
4 x No8 Screws

The spire clips must be fitted to the base of the hob prior to fitting the installation brackets.

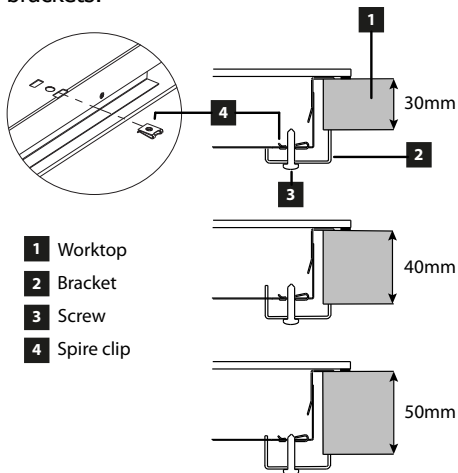

Installation pack 2

4 x Cranked installation bracket
4 x Spire clips (70/90cm appliances only)
4 x No8 Screws

Depending on your appliance the cranked bracket may or may not require the spire clips detailed in pack 1. If your appliance is not supplied with spire clips, the installation brackets screw directly into the base of the hob in the ported holes provided.

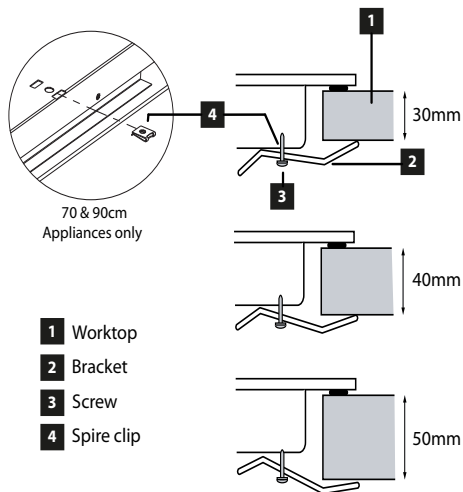

Important;

Do not modify this appliance.

INSTALLATION

CONNECT TO THE ELECTRICITY SUPPLY

WARNING: This appliance must be earthed. Only connect to the electrical mains terminal with the power switched off. The electrical mains terminal is live.

Follow the terminal block connection schematic

Loose and inappropriate connections can make the terminal overheat.

Ensure the cable clamp is fitted correctly and securely.

A device must be provided in the electrical installation which allows the appliance to be disconnected from the mains at all poles with a contact opening of at least 3mm.

We recommend that the appliance is connected by a competent person who is a member of a "Competent Person Scheme" who will comply with the required local regulations.

Connection should be made with a suitable cable.

- Firstly open the terminal block cover using a small flat bladed screwdriver in the door release tabs shown below.

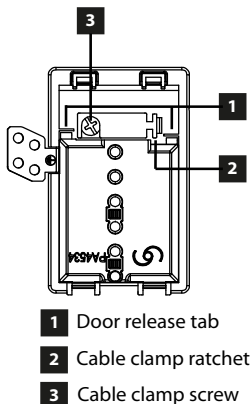

- Remove the cable clamp screw and release the cable clamp retaining arm.

Note;

The cable clamp has a ratchet type mechanism on the right hand side of the retaining arm.

- Strip the wires & connect to the terminal block as appropriate:-

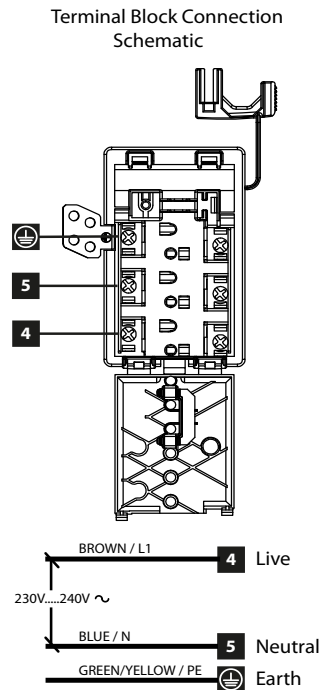

- Fit the cable clamp & secure with the screw provided.
- Close the terminal box, ensuring that the cover is closed and all screws are tight and in place.

Important: Ensure that you route all mains electrical cables well away from any adjacent heat source, such as the base of the hob an oven or grill.

TECHNICAL DATA

SUPPLY: 220 -240V ~ 50Hz 4.85kW - 6.20kW

Refer to the data badge on the under side of your hob for specific power rating of your model

CUSTOMER CARE

CUSTOMER CARE WEB SHOP

Having purchased a superior cooker, hob or hood from us, you'll naturally want to keep it looking great. And who better to help you care for it than the manufacturer?

We offer an extensive range of accessories, components and cleaning products which, will instantly give your cooker a good as new look.

In addition to the list of our most popular products below, we also have an exciting

range of Bake ware and Cookware essentials including Roasting Pans, Cake Tins and Non-Stick Cooking Liners.

For all enquires, please visit our Web Shop at www.gdhaonline.co.uk or call the Spares Sales Team on **0844 815 3745**. For countries outside the UK, please contact your local service agent.

Product Description	Where used	Purpose
Ceramic Hob Cleaner	All Ceramic glass hobs including Induction	Enables easier cleaning of your ceramic hob. Prevents build up of mineral deposits. Best used with Ceramic Hob Scraper Kit. 300ml bottle.
Ceramic Hob Scraper kit	All Ceramic glass hobs including Induction	Ideal for removing cooked on marks from ceramic glass hobs Best used with Ceramic Hob Cleaner
Sealed Hotplate Conditioner	All sealed/solid plate hobs	Restores the sleek matt black finish to solid hotplates
Multipurpose Kitchen Cleaner	General kitchen cleaner	Excellent multipurpose cleaner, For use around the kitchen. 500ml bottle.
Oven Cleaner	All cooking appliances.	Cuts through grease & burnt on grime. 500ml bottle
Restor-A-Cloth	All cooking appliances.	Chemical free cleaning cloth Ideal for cleaning & polishing glass & stainless steel
Stainless Steel Cleaner	All stainless steel parts	Oil based cleaner. Perfect for removing stubborn & greasy marks. 300ml bottle.
Rectangular carbon filters	Cooker Hoods	New filters, help to maintain efficient cooker hood operation and keep your Kitchen odour free
Round Carbon Filters	Cooker Hoods	New filters, help to maintain efficient cooker hood operation and keep your Kitchen odour free

Please keep this handbook for future reference, or for anyone else who may use the appliance.

Please keep this handbook for future reference, or for anyone else
who may use the appliance.

CUSTOMER CARE

To contact Belling about your appliance, please call

Warranty Registration

0844 481 0182

to register your appliance

Customer Care Helpline

0844 815 3746

in case of difficulty within the UK

Alternatively general, spares and service information is available from our website at
www.belling.co.uk

Please ensure that you have the product's model no and serial no available when you call. These can be found on the silver data label on your product which is located:

Ovens	Open the door; adjacent to the oven cavity
High-level grill products	Inside the base compartment
Hobs	On the underside of the product

Enter appliance numbers here for future reference:

Model No

--	--	--	--	--	--	--	--	--	--

Serial No

--	--	--	--	--	--	--	--	--	--

SERVICE RECORD

Date of purchase	Installed by	Installation Date
Place of purchase:		

Date	Part(s) replaced	Engineer's name

For customers outside the UK and Northern Ireland, please contact your local supplier.

Glen Dimplex Home Appliances, Stoney Lane, Prescott, Merseyside, L35 2XW