

**Built in oven**  
**INSTALLATION AND USER INSTRUCTIONS**

---

**Models: XOU60F**  
**XOU60FP**  
**XOU60MF**



# Contents

Introduction.....	4
Installing Your Cooker .....	5
Electrical connection.....	6
For your own safety - Never .....	7
-Always .....	7
Know Your Cooker .....	8
Using the Timer .....	
Operating the Minute Minder.....	9
5 Button Clock/Minute Minder.....	10
Using the Oven.....	15
Using the Grill.....	16
Care and Cleaning .....	20
Trouble shooting.....	21
Future transportation.....	21
Replacing the Oven Lamp.....	21
Service.....	Back Cover

This appliance conforms to the following EEC Directives:

Low Voltage Equipment

73/23/EEC

93/68/EEC

Electromagnetic Compatibility

89/336/EEC

92/31/EEC

93/68/EEC

EN30



# Introduction

## Your Belling Cooker

Thank you for purchasing a new Belling Cooker. Its stylish and practical design will enhance your kitchen and make cooking a pleasure. It features a fan oven or conventional oven, with a separate grill. Some models feature a fully programmable clock/timer with a minute minder and automatic oven switch on and off or a clock/minute minder. Even if you have used an electric before, it is important that you read these instructions thoroughly before starting to cook, paying particular attention to the installation and safety instructions.

## Getting Help

If you have any problems with installing, operating, or cooking with your Belling Cooker, please check through these instructions thoroughly to make sure that you have not missed anything. If you still need help, then please contact (including a daytime telephone number if possible):

Customer Care Centre  
Belling Appliances.  
Stoney Lane,  
Prescot,  
Merseyside.  
L35 2XW  
Telephone: 0870 444 9939

Please quote the cooker model and serial number with all enquiries. This can be found on the rating plate on the plinth below the oven door.

**WARNING! For your own safety, make sure that these instructions on installation, use and maintenance are followed.** We advise you to keep these instructions in a safe place for future reference.

If you sell or transfer ownership of this product, please pass on these instructions to the new owner.

# Installing your cooker

The control panel is cooled by a fan. And will continue blowing for a short period of time after completion of cooking. Please keep the door closed on completion of cooking.

- The oven can be either installed under a working surface or in a cupboard suitably sized, at eye level (see drawing).
- Centre the oven in the cupboard so as to leave a margin of 2mm from the adjacent cupboards.
- Cupboard material must be heat-resistant (or be covered with similar material).
- For greater stability, fix the oven in a cupboard with four screws in the holes provided for this purpose on the sides. Make a  $\text{Ø} 3\text{mm}$  hole beforehand in the cupboard wall to avoid the wood splitting.

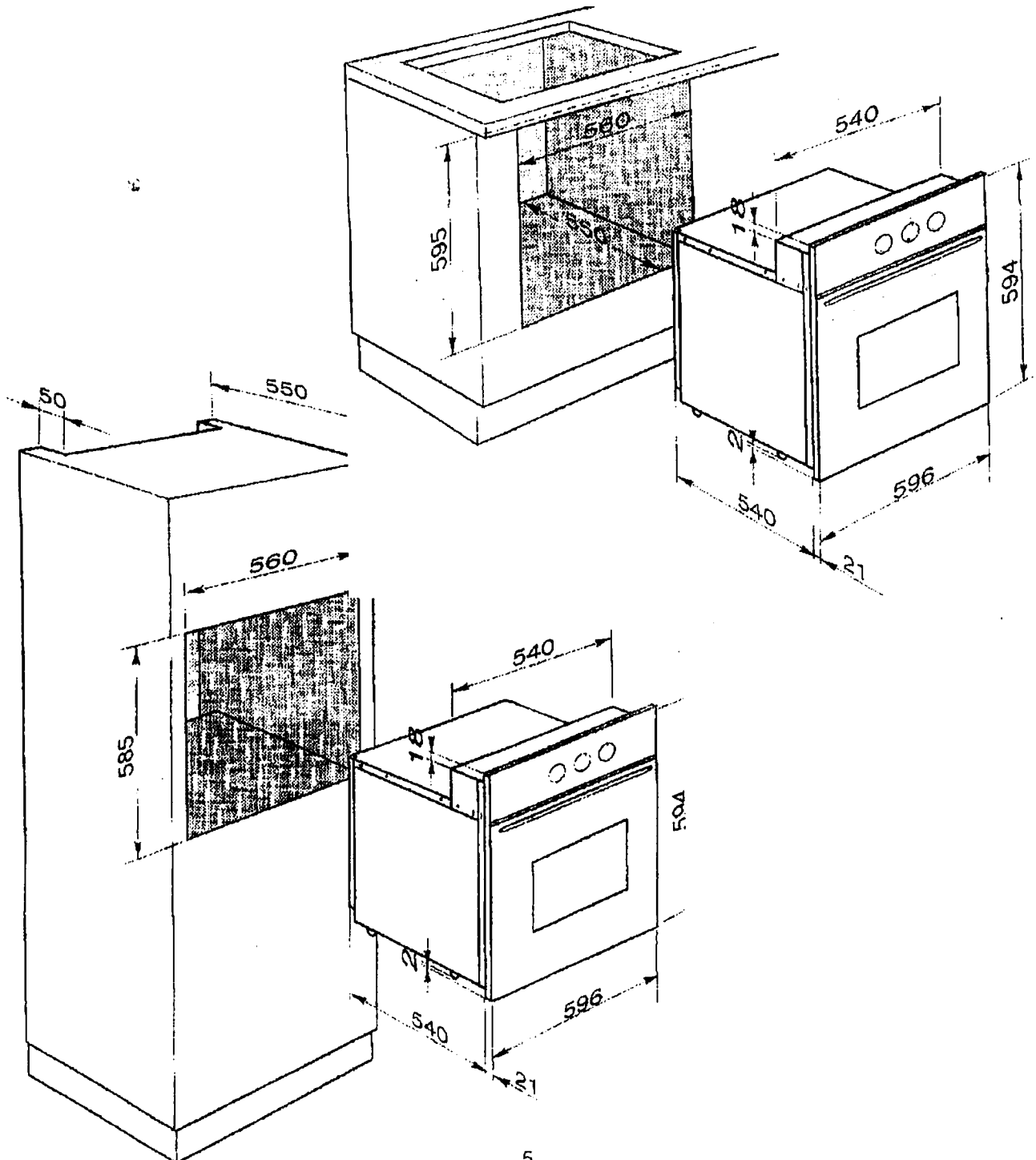

## Electrical connection

- Do not connect the appliance to the electricity supply until all packing and transit protectors have been removed.
1. Before your appliance is connected to the mains electricity supply, check to ensure that the voltage and frequency shown on the rating label corresponds with your power supply. You can see the label below the cavity when you open the oven door.
  2. This product must only be installed by a qualified electrician, eg local electricity company or a NICEIC registered contractor, to a suitable double-pole control unit with a minimum contact clearance of 3 mm in all poles and with a minimum rating of 16 A which should be fitted adjacent to ( but not above) the appliance in accordance with IEE regulations. Failure to observe this instruction may result in operational problems and invalidation of the product warranty.
  3. This appliance must be earthed.
  4. The mains cable must pass through the cable clamp.
    - If the supply cord is damaged, it must be replaced by a similarly qualified person in order to avoid a hazard.
    - The cable length should be 2m max for isolation safety.

### Mains cable routing

The mains cable should be routed away from the appliance, the ventilation slots and the vent outlet. It should not be obstructed when pushed in to position between the appliance and the wall or cabinet.

A cable of the correct size rating must be used.  
Cable type H05 V V-F 3x1.5 mm<sup>2</sup>

As the coloured wires in the mains lead for the appliance, may not correspond with the coloured markings identifying the terminals in your spur box, proceed as follows:

The earth wire must be connected to the terminal which is marked with the letter E or by the earth symbol  $\equiv$ .

The wire coloured black/blue must be connected to the terminal which is marked with the letter N (Neutral).

The wire coloured brown/red must be connected to the terminal which is marked with the letter L (Live).

### Important

This appliance is intended to be permanently connected to fixed wiring. We will not be liable in the event of an accident resulting from  $\equiv$  non existent, faulty or incorrect earthing.

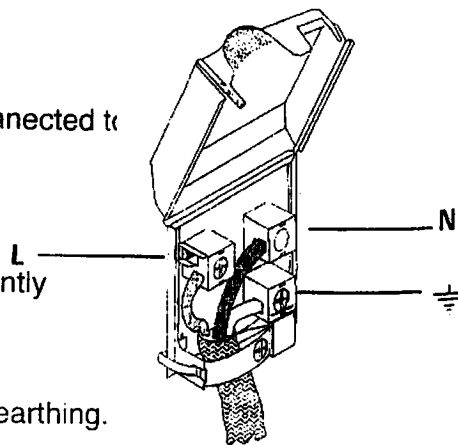

## For your safety

When used properly your Belling Forum is completely safe, but as with any electric appliance there are some precautions you must take in its use.

### Never..

- Never allow anyone except an authorised Belling Service Agent to service or repair your cooker.
- Never remove any part of the cooker other than those intended in normal use, or attempt to modify the cooker in any way.
- Never use the cooker for commercial catering. It is designed for domestic use and for cooking food only.
- Never allow young children to operate or play with the cooker, as all surfaces get hot while in use.
- Never allow children to sit or stand on any part of the appliance.
- Never store items above a cooker that children may attempt to reach.
- Never line the shelves, floor, or sides of the oven or grill, with aluminium foil as overheating and damage may result.
- Never place materials which might catch fire, such as tea towels on the hob or elements, even when the cooker is not in use.
- Never use an asbestos mat, trivet or rack of any kind under pans on the hob.
- Never store anything which might catch fire in the oven or grill.
- Never heat unopened containers.
- Never store flammable liquids, aerosols, etc. in adjacent cabinetry.
- Never operate the grill when the oven is set to cook automatically.

### Always..

- Always take care when touching any part of the cooker which may be hot. Use dry oven gloves when removing or replacing food or dishes. Care should be taken to avoid touching the heating elements inside the oven.
- Always stand back when opening the oven door to allow any build-up of heat or steam to disperse.
- Always keep the oven doors closed, when using as a grill. If grilling is performed with door open heat damage to control panel, knobs and the side panels will be experienced.  
**Grill door must be closed during grilling.**
- Always make sure that the roof, side and back panels, and shelves are fitted correctly before using the oven or grill.  
Always switch off at the mains supply and allow the cooker to cool before cleaning your cooker.
- Always supervise children and pets, particularly when grilling, as exposed parts of the cooker may become hot.
- Always make sure that all the controls are switched off when you finish cooking.
- Always remember that your cooker may stay hot for a time even after you have finished cooking.
- Always keep ventilation slots clear of obstructions.
- Always keep children away from cooker when cleaning at maximum vent setting.
- Always adjust the timer during the first operation or after any interruptions of the electric supply. Otherwise, your oven will not operate.

# Know Your Cooker

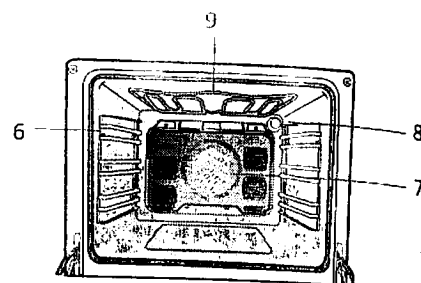
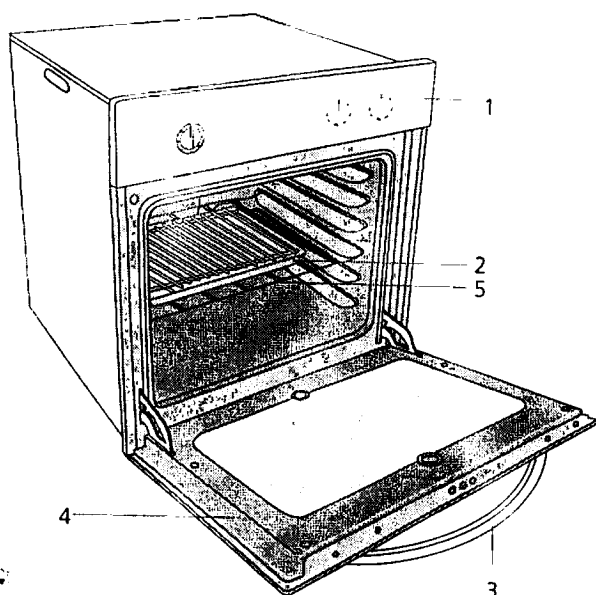

1. Control panel
2. Tray
3. Handle
4. Front door
5. Wire grill
6. Shelves
7. Turbo-motor (behind back over)
8. Lamp
9. Grill heating element

## Specification

	<b>XOU60F</b> <b>XOU60FP</b>	<b>XOUMF</b>
Outer width	596 mm	596 mm
Outer depth	561 mm	561 mm
Outer height	594 mm	594 mm
Dimensions of installation setting		
Width	: 560 mm	: 560 mm
Depth	: 540 mm	: 540 mm
Height	: 585 mm	: 585 mm
Supply voltage	: 230 V ~ 50 Hz	: 230 V ~ 50 Hz
Grill power	: 2100 W	: 2100 W
Oven power		: 2100 W
Turbo heating element	: 2000 W	: 2000 W
Ventilation motor	: 15 W (H-type)	: 15 W (H-type)
Lamp	: 15 W	: 15 W

## preparation and burning off

### Important for asthmatic sufferers

Before using for the first time, protective coatings need to be burnt off. Fumes will be emitted but this is quite normal.

**Ensure the room is very well ventilated during the burning off process. Avoid directly inhaling the fumes during this process.**

### Oven

Remove shelves and baking tray select "☉" and turn the oven control knob to 200°C for about 15 minutes.

### Cleaning

Before you start using your appliance, clean the appliance.

## operating the minute minder

The mechanical timer is adjustable up to 120 minutes.

To obtain 120 timer setting turn the knob clockwise until the end and then turn the knob anti-clockwise to the bar mark.

1- Turn the knob clockwise until the end.

2- Turn the knob anti-clockwise to the desired time.

3- At the end of the preset time a buzzer sounds which goes off after a while.

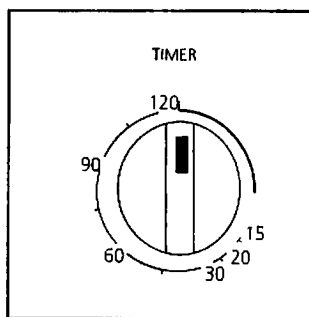

**This timer is for timing any process and does not cut the power.**



## 5 Button Clock/Programmer



The timer display is in 24 hour clock format.  
Ensure that the correct time of day is always set before using your cooker.

**A** will light:

- When the timer is first turned on it will flash. (It should go out when a time of day is set).
- When an Auto Cooking programme has been set.

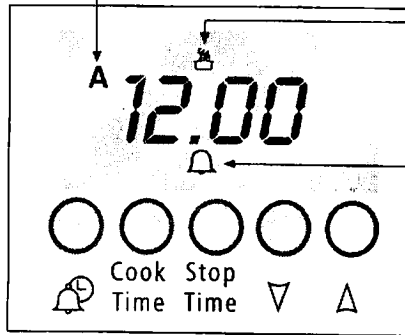

This "Cookpot" symbol will light up either.

- When the cooker is in "Manual Mode".
- When you press the  Cook Period button and set a length of time for an Automatic Cooking programme.

 symbol will light up during Automatic Cooking.

 will light up when you select a Minute Minder period and will remain lit for the period set.



### MINUTE MINDER

Here you can set a time period of up to 23 hours and 59 minutes that will count down. When it reaches zero the timer will bleep.

e.g. If you set 20 minutes, the timer will start beeping 20 minutes later.

### 'Cook Time' COOK PERIOD

Cook Period is the actual length of time for which, the timer will switch the oven(s) on as part of an "Automatic Cooking" programme.

e.g. If you set 2 hours, the food will be cooked for 2 hours.

### 'Stop Time' END TIME

The time of day at which you want an automatic cooking programme to end.

e.g. If you set a cook period for 2 hours, and end time of 11:00. The timer will switch the oven(s) on at 9:00 and turn the oven(s) off at 11:00. You will hear a bleep at 11:00 to indicate that the automatic cooking programme has finished.

### Notes

- When setting an automatic cooking programme you will need to set the oven control(s) to the required temperature(s) when you set the timer.
- If an automatic cooking programme has been set the oven(s) will only operate during the pre-programmed time.

### + and --

Used to adjust the various timer function settings.

- Used to adjust pitch of audible tone. (See **Clock and Automatic Timer Operation**).

### Setting the Time of Day

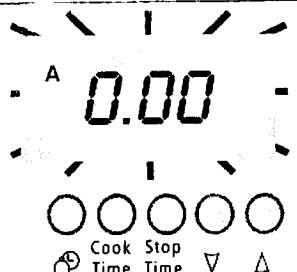

**Step 1** Make sure all oven controls are turned **OFF**.

**Step 2** Check the electricity supply to the cooker is turned **ON**.

When switched on the display will show *0.00* and the **A** symbol, both will be flashing.

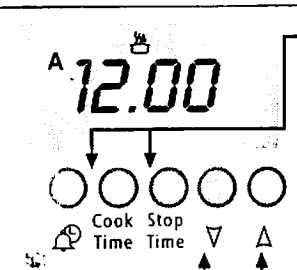

**Step 3** Press hold in both the 'cook time' cook period & 'stop time' end time buttons together.

**Step 4** With the 'cook time' cook period & 'stop time' end time buttons still held in, press either  $\nabla$  or  $\Delta$  buttons to set to correct time of day.

**Step 5** Release all the buttons simultaneously.

The time of day is now set and the '🔥' symbol will light up to show that the timer is in Manual Mode.  
**NOTE:** To change the time of day repeat steps 3, 4 & 5 above.

### Setting the Minute Minder

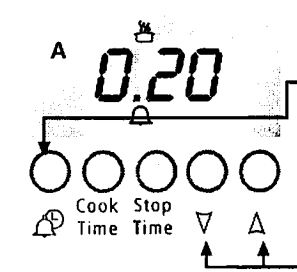

**Step 1** Ensure the time of day is set correctly.

**Step 2** Press and hold the  minute minder button.

**Step 3** With the button still held in set the required  minute minder time using 'Δ' and '∇' buttons.

A  symbol will light up.

**Step 4** Release all buttons and the timer display will revert back to the time of day.

The  symbol will remain lit to signify that a minute minder period has been set.

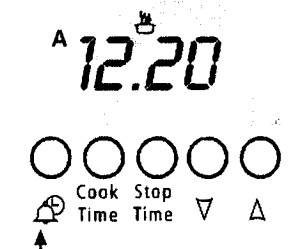

All the end of the set time a bleeping sound will be heard and the  symbol will go out. The bleeping sound will continue for several minutes unless cancelled (See Step 5)

**Step 5** To cancel the bleeping sound press the  minute minder button. The time display will revert back to the time of day after the button is released.

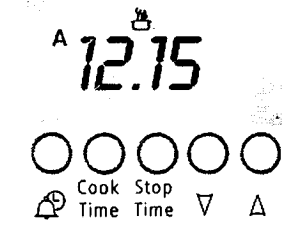

To cancel the minute minder before the minute minder period has finished.

**Step 1** Press the  minute minder button.

**Step 2** Press the '∇' button until *0.00* and the '🔥' symbol appears in the display window.

**Step 3** To cancel the bleeping sound press the  minute minder button.

#### Note

When the minute minder has been set the time remaining can be checked at any time by simply pressing the  minute minder button.

# Automatic Cooking Programmes

There are two automatic cooking programmes that can be selected using your timer.

(a) To set the timer to switch the oven ON and OFF automatically.

(b) To set the timer to switch on immediately and OFF automatically after a set cook period.

**(a) To set the timer to switch the oven ON and OFF automatically.**

This allows you to cook at a specific time for a chosen period before the oven switches off automatically.

**Step 1** Check that the correct time of day is set. If not follow instructions for setting the time of day.

**Step 2** Place food onto the correct shelf position in the oven and close the oven door.

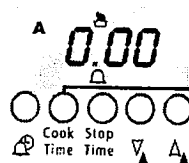

**Step 3** Press and hold the 'cook time' cook period button. The display will read 0.00 with the cookpot symbol 'A' lit.

**Step 4** With the 'cook time' cook period button still held in set the required cook period using A and buttons.

Release the buttons and the timer display will revert to the time of day with the A symbol and 'A' symbol lit.

**Step 5** Press and hold the 'stop time' end time button. The display will read the earliest possible time for the cook period that you have set above.

**Step 6** With the 'stop time' end time button still held in, use the + and - buttons to set the end time.  
i.e. The time you require the oven to switch off.

Release all the buttons and the timer will revert back to the time of day.

The A symbol will remain lit to signify that an automatic cooking programme has been set. The 'cook time' symbol will go out.

When the auto cook programme starts the 'cook time' symbol will then light up again.

**Step 7** Turn the oven control to the required temperature.

A 16.20

At the end of the automatic cook period the A symbol will flash and an intermittent beeping sound will be heard. The 'cook time' symbol will go out.

The beeping sound will continue for several minutes unless cancelled (see step 8). The A symbol will continue to flash until the timer is returned to manual operation (see below).

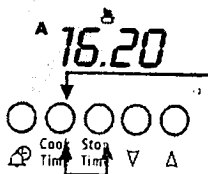

**Step 8** Press the 'cook time' cook period button to cancel the beeping sound.

**Step 9** Turn the oven control(s) to the OFF position.

**Step 10** Press the 'cook time' cook period and end time buttons together to return the oven(s) to manual operation. The A symbol will go out and the 'cook time' symbol will light up.

## Notes:

When cooking automatically the cook period can be checked at any time by simply pressing the 'cook time' cook period button and the 'stop time' end time by pressing the end time button.  
To cancel the auto cooking programme before or after auto cooking starts, press the 'cook time' cook period and 'stop time' end time buttons together. This will return the cooker to manual operation.

(b) To set the timer to switch ON immediately and OFF automatically after a set cook period.

**Step 1** Check that the correct time of day is set. If not follow instructions for setting the time of day.

**Step 2** Place food onto the correct shelf position in the oven and close the oven door.

**Step 3** Turn the oven control to the required temperature.

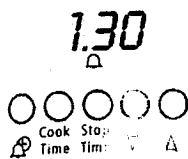

**Step 4** Press and hold the 'cook time' cook period button, the display will read 0.00 and the 'A' symbol will light up.

With the cook period button still held set the required cook period using the + and - buttons the **A** symbol will light up. e.g. 1 hour 30 minutes.

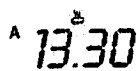

**Note:** The cook period is the length of time the food requires to cook.

**Step 5** Release all buttons.

The timer display will revert to the time of day with the **A** and 'A' symbols remaining lit.

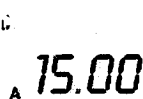

At the end of the cook period the **A** symbol will flash and an intermittent bleeping sound will be heard. The 'A' symbol will go out. The bleeping sound will continue for several minutes unless cancelled (see Step 6). The **A** symbol will continue to flash until the timer is returned to manual operation (see below).

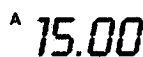

**Step 6** Press the 'cook time' cook period button to cancel the bleeping.

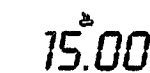

**Step 7** Turn the oven control(s) to the OFF position.

**Step 8** Press the 'cook time' cook period and end time buttons together to return the cooker to manual operation. The **A** symbol will go out and the 'A' symbol will light up.

When cooking automatically the cook period can be checked at any time by simply pressing the 'cook time' cook period button. To cancel the auto cooking programme before or after automatic cooking starts, press the 'cook time' cook period and 'stop time' end time buttons together. This will return the cooker to manual operation.

# Know your Control Panel

## XOU60F

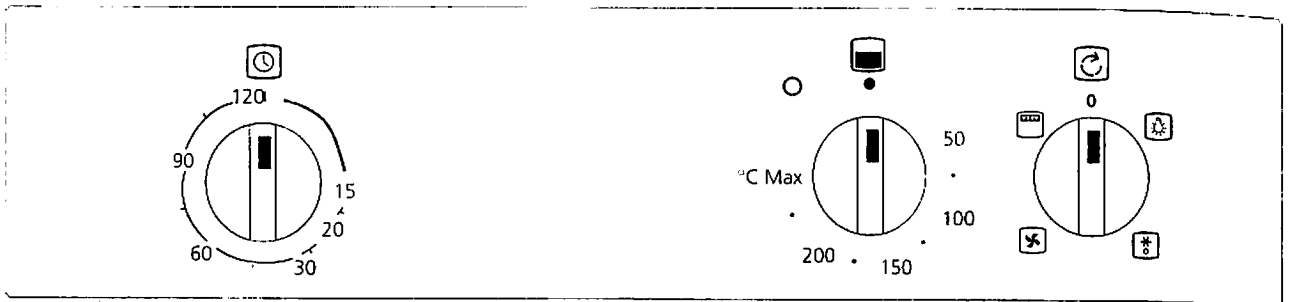

## XOU60MF

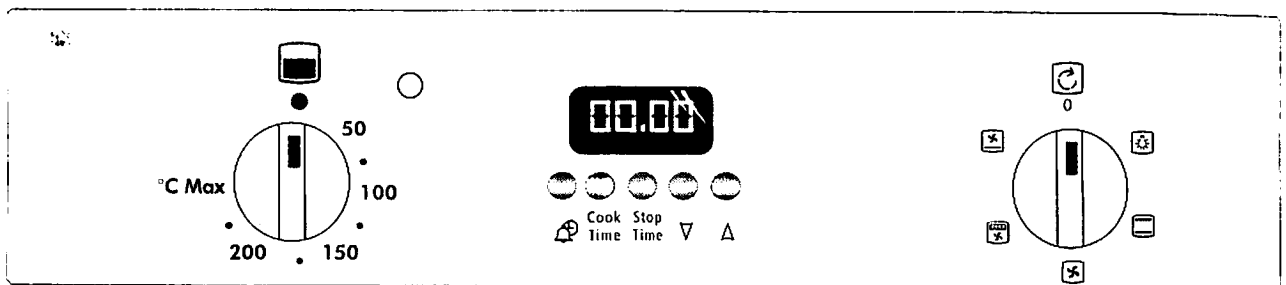

## XOU60FP

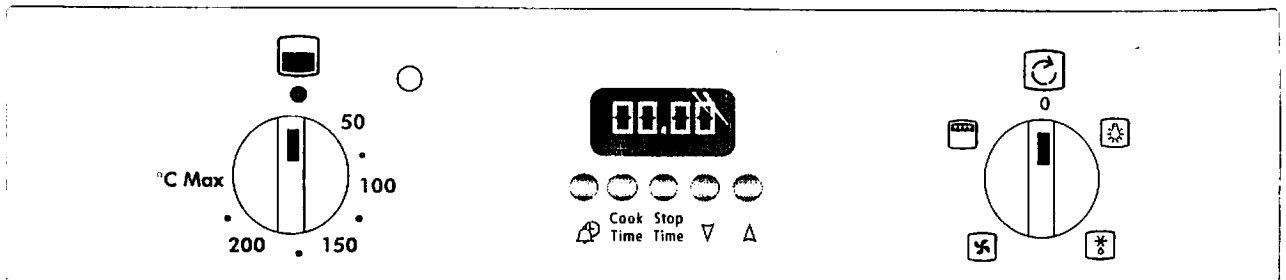

## Using the oven

**Don't touch the heating elements or other parts that may become hot when the oven is in use - children must be kept away!**

- 1 Turn the oven on by rotating the oven control knob to  position.
- 2 Select the temperature in the oven by selecting the temperature (in degrees Celsius) printed on the knob.
- 3 The amber temperature indicator light on the control panel will glow until the pre-set temperature set is reached.
- 4 Once the temperature has been reached, the amber light will go off and then cycle on and off to maintain the pre-set temperature.

**Ensure you stand back from the appliance when opening the oven door to allow any build up of steam or heat to escape.**

- Check food is thoroughly cooked and is piping hot.
- As a fan oven heats up more quickly and generally cooks food at a lower temperature than a conventional oven, preheating the oven is often unnecessary. However, food such as bread, scones, Yorkshire pudding, do benefit from being placed in a pre-heated oven.

### The features of the function selection knob

#### XOU60F / XOU60FP



Oven lamp light on.  
The heating elements are out of operation.

---



Fan (defrost)

---



Fan and turbo heater are on.

---



Only the grill heater is on. You must set the control knob to the maximum temperature.

---

#### XOU60MF



Oven lamp light on.  
The heating elements are out of operation.

---



Top and bottom heaters are on.

---



Fan and turbo heater are on.

---



Fan and grill heater are on.

---



Fan and oven bottom heater are on.

---

## Shelf Positions

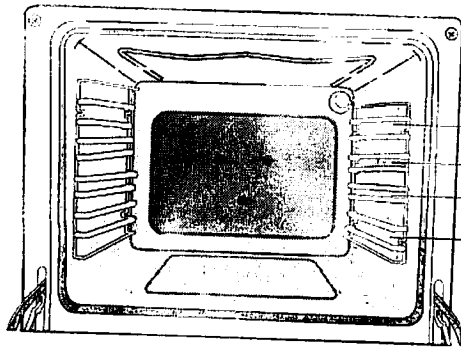

4 th shelf  
3 rd shelf  
2 nd shelf  
1 st shelf

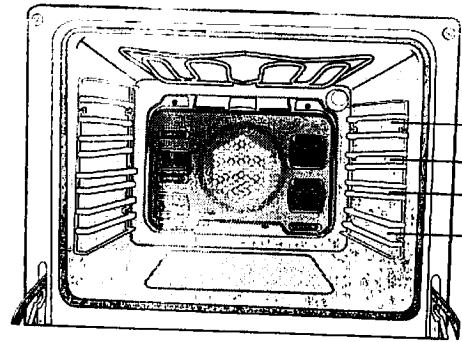

4 th shelf  
3 rd shelf  
2 nd shelf  
1 st shelf

### Special notes for fan ovens:

As a fan oven heats up more quickly and generally cooks food at a lower temperature than a conventional oven, preheating the oven is often unnecessary.

However, food such as bread, scones, Yorkshire pudding, do benefit from being placed in a pre-heated oven.

The temperature charts are a guide only, giving approximate cooking temperatures and times. To suit personal taste and requirements it may be necessary to increase or decrease the temperature by 10°C. Unless otherwise indicated in the charts, food is placed in a cold oven, ie. without pre-heating. If food is placed in an already hot oven, the suggested cooking time should be reduced, depending on the type and quantity of food being cooked.

An additional shelf can be purchased from Belling Spares (tel. 08704589661) if required for batch baking.

### Important note (Conventional Oven)

The conventional oven has an element situated under the floor of the cavity.

**DO NOT STORE PANS IN THE CAVITY WHEN THE OVEN IS IN USE!**

To avoid the possibility of a fire hazard, keep the cavity clean and free from build up of fat and grease.

Celsius ∞C	Fahrenheit ∞F
70	150
80	175
100	200
110	225
120	250
140	275
150	300
160	325
180	350
190	375
200	400
220	425
230	450
250	480

## COOKING GUIDE

### XOU60F / XOU60FP Models

Dishes	Pos.	Temp setting	Rack pos	Cooking time
<b>White meat</b>				
Roast pork		170°	2	30/1lb+3t30
Pork chops		230°	3	10-15
Chicken		175°-200°	1	55
Turkey / duck		190°	1	12/1lb+20
Sausages (1 lb)		220°	3	10
<b>Red meat</b>				
Casserole beef		140°	2	1h30
Lamb chops		225°	3	10-15
Roast beef rare		200°-225°	3	15/1b+20
Lamb		175°	2	25/1lb+25
<b>Fish and various meat</b>				
Kebabs		225°	3	15-20
Grilled fish		220°	3	15-20
Steak		230°	3	10
Baked fish		175°-200°	2	45
<b>Vegetables</b>				
Jacket potatoes		200°	2	1h-1h30
Roast vegetables		200°	1	1h-1h30
Roast potatoes		200°	1	45-60
Rice		200°	1	45
Stuffed pepper		175°-200°	2	40
<b>Cakes and pastry</b>				
Sponge cake		160°	2	25-30
Cake- Madeira cake		150°	2	1h-1h10
Scones		225°	3	10-12
Meringues		100°	2	2h20-2h40
Small cakes		160°	2	20-25
Choux pastry		200°	3	35-45
Angel cakes		150°	2	40-60
Short breads -Rich		150°	3	15-20
Short crust pastry		180°	2	10-20
Fruit crumble		160°	2	1h-1h20
Short or puff pastry		180°	2	30-40
Fruit pie		150°	1	35-40
Tart base		160°	2	15-25
Baked custards		150°	2	20-30
Rich fruit cake		130°	1	3h30
Lemon-meringue pie		pastry 180° meringue 130°	2	15 20-25
<b>Various</b>				
Steak and kidney pie		180°	2	1h30-1h40
Rice pudding		130°	1	1h30
Yorkshire pudding		180°	2	15-20
Bread base pizza		200°	1	15-25
Quiche		180°	2	40
Souffles		175°	1	45
Bread		200°	1	30-40
Lasagne				

### XOU60MF Models

Pos.	Temp setting	Rack pos	Cooking time
	190°	2	30/1lb+3t30
	225°	3	15-20
	200°	2	20/1lb+20
	200°	1	30/1lb+20
	225°	3-4	10
	150°	2	1h30
	225°	3-4	10-20
	220°	2	15/1b+20
	190°	2	25/1lb+25
	230°	3-4	15-20
	230°	3-4	15-20
	230°	3	10
	200°	2	45
	200°	2	1h-1h30
	195°	1	1h-1h30
	195°	1	45-60
	200°	1	45
	200°	2	40
	175°	2	25-30
	175°	2	1h-1h10
	225°	3	10-12
	110°	2	2h20-2h40
	175°	2	20-25
	200°	3	35-45
	160°	2	40-60
	175°	3	15-20
	225°	2	10-20
	175°	2	1h-1h20
	200°	1	30-40
	200°	1	35-40
	175°	1	15-25
	170°	2	20-30
	150°	1	2h30
	pastry 200° meringue 150°	2	15 20-25
	200°	2	1h30-1h40
	150°	1	1h30
	200°	1	15-20
	250°	1	15-25
	225°	1	40
	175°	1	45
	225°	1	30-40
	200°	2	40

10 minutes preheating for all cooking

Grilling and cooking must only be undertaken with the door closed.

The settings and time given in this chart are average. Experience will enable you to adapt them to your own cooking methods.



## Using the grill

Don't touch the heating elements or other parts that may become hot when the grill is in use - children must be kept away!

Do not allow children to sit or stand on the oven door when the door is open.

• **On completion of grilling or cooking always close the oven door after use to protect surrounding surface's from heat damage.**

### Using as a grill

When the door is fully open, it remains tilted slightly, so that any spillage will be directed away from you.

1 The door must be closed during cooking and grilling.

2 Turn the grill on by rotating the oven control knob to  (grill setting) position.

3 Set the grill control to required temperature in the oven.

4 Apply oil on the grill tray shelf to prevent meat from sticking on the bars.

5 Locate a tray to one of the bottom shelves in order to collect spillage and for easy cleaning put some water in it.

- Ensure the food is correctly positioned under the grill element.
- Food which requires browning only should be placed under the hot grill, either in the grill pan. The grill pan wire grid can be removed.
- Do not line the grill pan with aluminium foil. As this will result in an increase in temperatures a risk of fire/ damage to your appliance.
- Do not switch on the grill when using the compartment for storage.
- During grilling operation constant supervision is required.

**Grilling must only be performed with the oven door closed otherwise heat damage could occur to surrounding surfaces and control panel.**

## Grilling Guidelines

Use the following chart for guidelines.

For thicker foods requiring longer cooking, turn the control to a lower setting after the initial sealing on both sides. The thicker the food, the lower the control should be set. When grilling thicker food, the grill rack should be turned over to its lowest position.

Food	Grill Setting	Approximate Cooking time
Toasting of Bread products	230	3 - 10 mins.
Small cuts of meat, sausages, bacon, etc.	220-230	15 - 20 mins.
Chops etc. Gammon steaks Chicken pieces	200-230	20 - 25 mins. Wire food support used in upturned position for chicken.
Fish: Fingers Whole Fillets	220	10 - 20 mins. Whole fish and fillets placed in the base of the grill pan.
Fish in breadcrumbs	220	15 - 20 mins.
Pre - Cooked potato products	200-220	15 - 20 mins.
Pizzas	220-240	12 - 15 mins. in the base of the grill pan.
Browning of food	230	8 - 10 mins. Dish placed directly on the base of the grill compartment

## Use of Grill Pan Handle

**Warning! Always use an oven glove to protect your hand when using the grill as all metal parts can become very hot.**

The grill pan has a detachable handle. Make sure the handle is securely located between the raised profiles across the front of the grill pan. See the diagrams for fitting the handle. To remove the handle, reverse the sequence of operations.

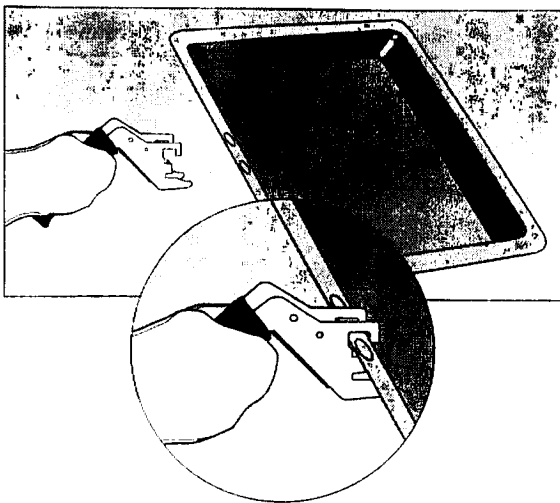

**Always take care not to touch hot surfaces when using the grill panhandle. Ensure when using the grill panhandle that it is centralized and secure. Do not leave the handle in position when grilling. If the handle is left in position when grilling, it will get very hot.**

## Care and Cleaning

Turn OFF at the mains before cleaning.

- Before switching on again ensure that all controls are in the OFF position.
- Make sure that the oven and grill are sufficiently cool before you start cleaning.

### Control panel

Wipe over the control panel with a damp cloth and polish with a dry cloth. Do not use oven cleaners or aerosols, scouring pads or abrasive powder for cleaning the plastic knobs or end caps as damage will occur. Do not attempt to remove any of the control knobs from the panel as this may cause damage and is a safety hazard.

### Oven Section

Before switching on again ensure that all controls are in the OFF position. Remove all trays and the grill pan out of the oven. Clean out the interior with a moist, soapy cloth. Then, clean it once more with a wet cloth and let it dry.

**Do not use dry powder agents for cleaning.**

Special cleaners that are commercially available may be used after carefully reading the warning that are written on the labels.

### Warning!

Never clean the inside of the oven and trays with hard brushes, steel pads or knives.

Do not use cleaning agents containing acid or chlorine on **stainless steel surfaces or the handle**. Cleaning can be accomplished using a soft cloth and soapy water or with commercially available special surface cleaners and a soft cloth.

### Door

Wipe over the door outer panels with a cloth wrung out in hot soapy water, then after wiping with a cloth wrung out in clean water, dry with a soft clean cloth. Do not use scouring pads or abrasive powder which may scratch the surface.

Take care during cleaning not to damage or distort the door seal. Ensure that the door seal is dry after cleaning. Do not lift the door seal.

### Over time...

- Slight discolouration of liners and other surfaces may occur in time. This does not affect the functioning of the appliance.

### Oven & Grill compartments

Remove the grill/meat pan and grid. It is best to wash these items immediately after use to prevent stains from being burnt on when used again.

Wipe around the oven or grill compartment, removing stubborn stains with a fine soap impregnated steel wool pad. Harsh abrasives should be avoided.

Remove the rod shelf for washing at the sink. Use a fine steel wool soap pad for removing stubborn stains from the rod shelf and floor of the oven. Take care during cleaning not to damage, bend or dislodge from the supporting clips the thermostat phial which is across the back of the oven just below the roof in the oven compartment.

## trouble shooting

### If the appliance does not work

If the appliance does not operate check whether:

- The power supply is on.
- The fuse has blown/circuit breaker has tripped/main distribution switch has been turned off.
- The control has been set correctly.
- Oven programmer has been reset.

If the appliance is still not operating after the above checks, please refer to the section on how to obtain service.

Please ensure that the above checks have been made as a charge will be made if no fault is found.

### Performance characteristics when in use

#### • When using your appliance for the first few times, an odour and/or smoke may be emitted which is normal

- It is normal for the metal parts to produce noise when in use, this is due to expansion and contraction.
- When in use, steam may be produced which is normal and not a fault of the appliance.
- At the end of a cooking session, it is normal to have a momentary puff of steam when the oven door is opened. This should disperse in a few seconds.
- If, whilst cooking, steam produced comes in contact with cool surface's on the outside of the appliance, it will condense and produce water droplets. This is quite normal and is not a fault.

## future transportation

Keep the original carton and other packaging material in a safe place. Transport the appliance in its original carton. Follow the instructions that are printed on the carton.

To prevent the accessories inside the oven from damaging the oven door, tape a strip of cardboard onto the inside of the oven door that lines up with the position of the trays. Tape the oven door to the side walls.

### If you do not have the original carton

Take the necessary precautions in order to prevent the exterior panels, and the glass surfaces of the oven from being damaged.

Pack the oven in bubble wrap or thick cardboard and tape it securely in order to prevent damage during transportation.

The oven must be transported upright. Do not place other items on the top of the appliance.

## replacing the oven lamp

**Ensure that the appliance is switched off before replacing the lamp to avoid the possibility of electric shock.**

1. Switch off at the mains.
2. Remove the protective glass cover of the lamp inside your oven by turning it anti-clockwise.
3. Remove the bulb by turning it anti-clockwise.
4. After installing the correct replacement bulb, reinstall the protective glass of the lamp. Replacement light bulb can easily be obtained from a good local electrical or DIY store.