



belling

---

**INSIDE  
EVERY  
GREAT  
HOME**

---



User Manual

[www.belling.co.uk](http://www.belling.co.uk)

Belling Built In 60cm

Date: 03/12/2021

**Countries of destination:**

GB - Great Britain   
IE - Ireland   
DE - Germany  
ES - Spain

FR - French  
IT - Italy  
PL - Poland  
NL - Netherlands

SE - Sweden  
CN - China  
NZ - New Zealand  
AU - Australia

To contact Belling about your appliance, please call:



**Customer Care Helpline**  
**0344 815 3746**

in case of difficulty within the UK



**Warranty Registration**  
**0800 952 1068**

\*Please call our Customer Care team for extended warranty



**Spares Store**  
**0344 815 3745**



To register your appliance online:  
**[www.belling.co.uk](http://www.belling.co.uk)**



To contact us by email:  
**[gdhainfo@gdha.com](mailto:gdhainfo@gdha.com)**



To register your appliance by mail:  
**Please complete the warranty card  
and return to the address supplied**



Alternatively general, spares and service information is available from  
our website at: **[www.belling.co.uk](http://www.belling.co.uk)**

Calls are charged at the basic rate, please check with your telephone service provider for exact charges

Your new appliance comes with our **12-month guarantee**, protecting you against electrical and mechanical breakdown. To register, please complete the registration form included, register online or by phone. For full terms & conditions of the manufacturer's guarantee, please refer to the website above. In addition, you may wish to purchase an extended warranty. A leaflet explaining how to do this is included with your appliance.

Our policy is one of constant development and improvement, therefore we cannot guarantee the strict accuracy of all of our illustrations and specifications. Changes may have been made subsequent to publishing.

Glen Dimplex Home Appliances, Stoney Lane, Prescott, Merseyside, L35 2XW

# INTRODUCTION

---

## ACKNOWLEDGEMENT

Thank you for purchasing our product. We hope you enjoy using the many features and benefits it provides.

This user guide book is designed to help you through each step of owning your new product.

Please read it carefully before you start using your appliance, as we have endeavored to answer as many questions as possible, and provide you with as much support as we can.

General information, spares and service information is available from our website.

Ensure that other people using the product are familiar with these instructions as well.

If you should find something missing from your product or have any questions that are not covered in this user guide, please contact us (see contact information inside the front cover).

## European directives



This appliance is marked according to the European directive 2012/19/EU on Waste Electrical and Electronic Equipment (WEEE).

By ensuring this product is disposed of correctly, you will help prevent potential negative consequences for the environment and human health, which could otherwise be caused by inappropriate waste handling of this product. The symbol on the product indicates that this product may not be treated as household waste. Instead it shall be handed over to the applicable collection point for the recycling of electrical and electronic equipment. Disposal must be carried out in accordance with local environmental regulations for waste disposal. For more detailed information about treatment, recovery and recycling of this product, please contact your local city office, your household waste disposal service or the shop where you purchased the product

This appliance conforms to European Directive regarding Eco design requirements for energy-related products.

## DECLARATION OF COMPLIANCE

When you have unpacked the oven, make sure that it has not been damaged in any way. If you have any doubts at all, do not use it: contact a professionally qualified person. Keep packing materials such as plastic bags, polystyrene, or nails out of the reach of children because these are dangerous to children.



### UK ONLY GAS WARNING:

If you smell gas, Do not try to light any appliance. Do not touch any electrical switch.  
Call the Gas Emergency Help line at **0800 111999**

# SAFETY

---

## WARNING

- During use the appliance becomes hot. Care should be taken to avoid touching heating elements.
- Children less than 8 years of age shall be kept away unless continuously supervised. This appliance can be used by children aged from 8 years and above and persons with reduced physical sensory or mental capabilities or lack of experience and knowledge if they have been given supervision or instruction concerning the use of the appliance in a safe way and understand the hazards involved. Children shall not play with the appliance. Cleaning and user maintenance shall not be made by children without supervision.
- Do not use harsh abrasive cleaners or sharp metal scrapers to clean the oven door glass since they can scratch the surface, which may result in shattering of the glass.
- Do not use a steam cleaner on any range cooker, hobs and oven appliances.
- Ensure that the appliance is switched off before replacing the lamp to avoid electric shock.
- Never put items directly on the base of the oven or cover the oven base with foil, as this can cause the base element to overheat.
- When the oven is first switched on, it may give off an unpleasant smell. Please use the conventional or fanned cooking function at 250°C for 90 minutes to clean oil impurities inside the cavity. Ensure that the room is well ventilated during this process.
- Do not allow children to go near the oven when it is operating, especially when the grill is on.
- The means for disconnection must, be incorporated in the fixed wiring in accordance with the wiring specifications.
- An all-pole isolation switch must be incorporated into the fixed wiring in accordance with the wiring rules in force .
- If the supply cord is damaged, it must be replaced by the manufacturer, its service agent or similarly qualified persons in order to avoid a hazard.
- This appliance must be fitted to a switch providing all pole

disconnection with a minimum contact separation of 3mm.

- Connection should be made with a suitable flexible cable with a minimum temperature rating of 70°C.
- Although every care has been taken to ensure this appliance has no sharp edges. We recommend that you wear protective gloves when installing and moving this appliance. This will prevent injury.
- Always switch off your appliance and allow it to cool down before you clean any part of it.

## **CAUTION**

- This appliance must not be installed behind a decorative door in order to avoid overheating.
- The cooking process has to be supervised. A short term cooking process has to be supervised continuously.
- Ensure shelving is correctly installed, see the sections on shelf runners and shelf location within this book

## **FIRE SAFETY ADVICE**

If you do have a fire in the kitchen, don't take any risks - get everyone out of your home and call the Fire Service.

### **If you have an electrical fire in the kitchen:**

- Pull the plug out, or switch off the power at the fuse box - this may be enough to stop the fire immediately
- Smother the fire with a fire blanket, or use a dry powder or carbon dioxide extinguisher
- Remember: never use water on an electrical or cooking oil fire.

### **Other safety advice**

- Servicing should be carried out only by authorised personnel.
- Do not operate the appliance without the glass panels correctly fitted.
- There is a risk of electric shock, so always make sure you have turned off and switched your appliance off at the wall before starting any cleaning or maintenance. Always allow the product to cool down before you change a bulb.
- Do not modify the outer panels of this appliance in any way.
- This appliance must be earthed.
- The appliance must never be disconnected from the mains supply during use, as this will seriously affect the safety and performance, particularly in relation to surface temperatures becoming hot and gas operated parts not working efficiently. The cooling fan (if fitted) is designed to run on after the control knob has been switched off.
- **GAS WARNING!** - If you smell gas: Do not try to light any appliance, Do not touch any electrical switch. Contact the national gas emergency service on 0800 111 999.

# GETTING TO KNOW YOUR APPLIANCE

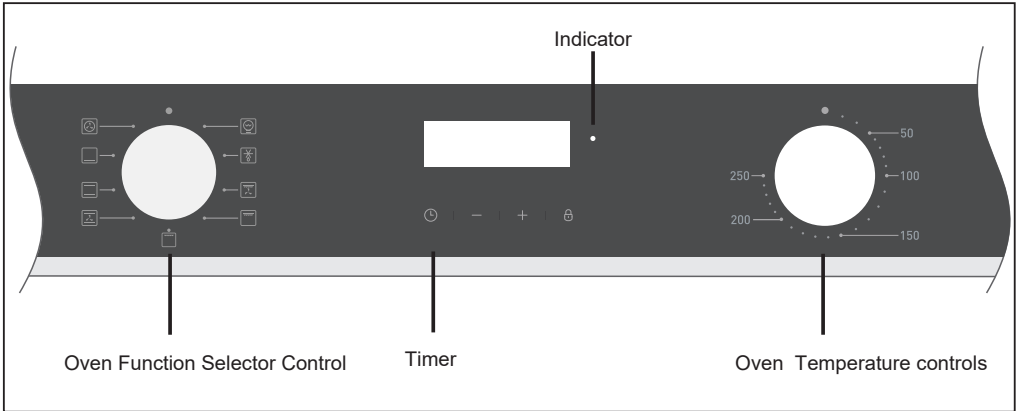

## BEFORE FIRST USE

1. Remove all stickers, surface protection foils and transport protection parts.
2. Remove all accessories and the side-racks from the cavity.
3. Clean the accessories and the side-racks thoroughly using soapy water and a dish cloth or soft brush.
4. Ensure that the cavity does not contain any leftover packaging, such as polystyrene pellets or wooden piece which may cause risk of fire.
5. Wipe the smooth surfaces in the cavity and the door with a soft, wet cloth.
6. To remove the new-appliance smell, heat up the appliance when empty and with the oven door closed.
7. Keep the kitchen highly ventilated while the appliance is heating up first time. Keep children and pets out of the kitchen during this time. Close the door to the adjacent rooms.
8. Adjust the settings indicated. You can find out how to set the heating type and the temperature in the next section.

Settings	
Heating Mode	
Temperature	250°C
Time	1h

### **After the appliance has cooled down:**

1. Clean the smooth surfaces and the door with soapy water and a dish cloth.
2. Dry all surfaces.
3. Install the side-racks.

### **Setting the time of day**









This can be done when the appliance is first connected to the power supply or at any point afterwards providing the oven is in standby (i.e not operating)

The clock is displayed as "hh:mm" and is a 24 hour clock.

1. Press the Clock Function key repeatedly until the clock symbol flashes.
2. While the clock symbol is flashing, use the plus and/or minus keys to set the current time of day.
3. About 5 seconds after the last press of the plus or minus key, the clock symbol stops flashing and the time of day has been accepted.

**Notes:** Always set the time of day before using the automatic cooking programme, because if you change the time of day after setting an automatic cooking programme, then the automatic cooking programme will be cancelled.

# OVEN/GRILL FUNCTIONS

Heating Mode	Temperature	Use
 Lamp	/	For lightening the cavity without any heating element switch on.
 Defrost	/	For gently defrosting frozen food.
 Double Grill + Fan	50°C~250°C	For roasting poultry, fish and larger pieces of meat. The heating element and The fan circulates the hot air around the food.
 Double Grill	50°C~250°C	For grilling flat items for grilling, such as steaks,sausages,toast and so on. The whole area below the heating element becomes hot.
 Radiant Heat	50°C~250°C	For grilling small amounts of steaks or sausages. The center area under the heating heating element becomes hot
 Conventional + Fan	50°C~250°C	For baking and roasting on one or more levels.(But no more than 3) The fan distributes heat from heating elements evenly around the cavity.
 Conventional	50°C~250°C	For traditional baking and roasting on one level. Especially suitable for cakes with moist toppings.
 Bottom	50°C~250°C	For preparing pizza and dishes which require a lot of heat from underneath. The bottom heating element heats up and the fan distributes heat evenly around the cavity.
 Convection	50°C~250°C	An element around the convection fan provides an additional source of heat for convection style cooking.

## Notes:

- To defrost big portions of food, it is possible to remove the side-racks and place the container on the cavity floor.

## Cooling fan

When cooking is finished, paused, or if the center oven temperature is over 75°C, the cooling fan will continue working for 15 minutes. When the center oven temperature drops below 75°C, the cooling fan will stop.



# USING YOUR APPLIANCE

---

## **To select a cooking function and cooking temperature**

Begin by turning Function Selector to point at the desired cooking function. Rotate Temperature Control to point at the desired cooking temperature. This can be adjusted during use. Note that some functions (light only, defrost etc) will not have a temperature option. The oven will begin to heat up to the desired function and temperature.

## **To activate and deactivate the Child Lock function**

Child lock can be activated to stop the product from being accidentally turned on. Press and hold the Start/Confirmation and the Pause/Off keys until a beep is heard. A lock symbol will appear on the display. This indicates that the Child Lock function has been activated.

To deactivate, press and hold the Start/Confirmation and the Pause/Off keys until a beep is heard. The lock symbol will disappear from the display and the appliance can be used as normal.

# CLOCK / PROGRAMMABLE TIMER

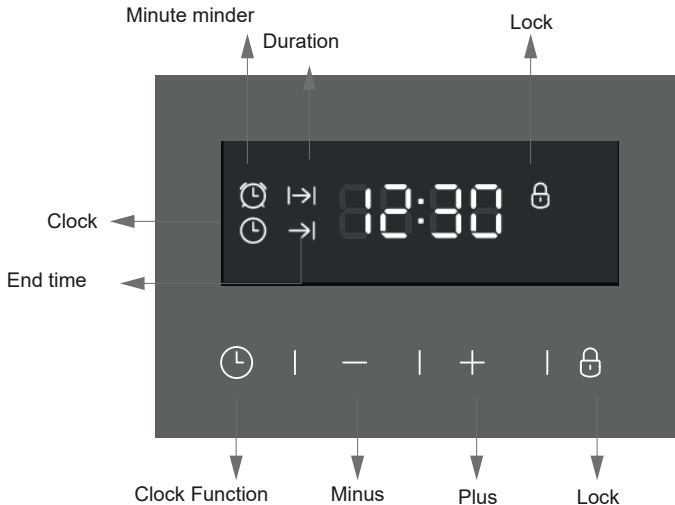

## SETTING THE MINUTE MINDER

The minute minder does not switch the oven off automatically. A minute minder duration time of between 1 minute and 23hr 59 minutes can be selected.

The clock is displayed as "hh:mm".

1. Press the function key repeatedly until the Minute minder symbol starts to flash.
2. While the Minute minder symbol is flashing, use the plus and/or minus keys to set the required minute minder duration time.
3. About 5 seconds after the last press of the plus or minus key, the minute minder duration time is accepted and starts to count down.
4. When the minute minder duration time has elapsed, the buzzer will sound. Press the any key to silence the alarm and the display returns to showing the current time of day. If you do not silence the alarm, it will be silenced automatically after approximately 2 minutes.

### Check or modify the minute minder

Press the function key repeatedly until the Minute minder symbol starts flashing again and the remaining minute minder duration time is displayed.

While the Minute minder symbol is flashing, you can press the plus and/or minus keys to adjust the minute minder duration time.

### Cancel the minute minder

Adjusting the minute minder duration time down to zero would cancel the minute minder function. About 5 seconds after the last press of the plus or minus key, the updated minute minder duration time is accepted and starts to count down.

## SEMI-AUTOMATIC COOKING

Semi-automatic cooking allows the main oven to switch off automatically after a specified time.

**Note:** Make sure that the correct time of day has been set on the timer.

1. Place the food in the main oven, and select the cooking function and temperature.
2. Press the clock function key repeatedly until the 'cooking duration' symbol |->| starts to flash.
3. While the cooking duration time symbol is flashing, use the plus and/or minus keys to set the required cooking duration time. A duration time of between 1 minute and 23 hours 59 minutes can be set.
4. About 5 seconds after the last press of the plus or minus key, the cooking duration time is set and begins to count down.
5. When the cooking duration time has elapsed, the oven will stop cooking and buzzer sounds. Turn the function knob and the thermostat knob back to the off position.
6. Press any key once to silence the buzzer. If you do not silence the buzzer, it will be silenced automatically after 2 minutes.

Press the Clock Function key again and the oven is back in manual mode.

### Check, modify or cancel the cooking duration time

If you need to check or change the cooking duration time, press the clock function key repeatedly until the cooking duration time symbol starts flashing again, and the remaining cooking duration time is displayed.

While the cooking duration time symbol is flashing, press the plus and/or minus keys repeatedly to adjust the cooking duration time.

Adjusting the cooking duration time down to zero would cancel the semi-automatic cooking function.

About 7 seconds after the last press of the plus or minus key, the updated cooking duration time is set and begins to count down.

## FULLY AUTOMATIC COOKING

Fully-automatic cooking allows the main oven to switch on and off automatically. You can enter the 'cooking duration time' and the time at which you want the food to be ready, and the timer will calculate the start time.

**Note:** Make sure that the correct time of day has been set on the timer. Place food in the oven.

1. Press the function key repeatedly until the cooking duration time symbol |->| starts to flash.
2. While the cooking duration time symbol is flashing, use the plus and/or minus keys to set the required cooking duration time. A duration time of between 1 minute and 23 hours 59 minutes can be set. About 5 seconds after the last press of the plus or minus key, the cooking duration time is set.
3. Press the function key repeatedly until the 'cooking end time' symbol ->| starts to flash.
4. While the cooking end time symbol is flashing, use the plus and/or minus keys to set the required cooking end time. A cooking end time can be selected up to 23 hours and 59 minutes after the 'current time of day'.
5. Select the cooking function and temperature as usual.
6. When the cooking end time arrives, the buzzer sounds. Turn the function knob and the thermostat knob back to the off position.
7. Press any key once to silence the buzzer. If you do not silence the buzzer, it will be silenced automatically after about 2 minutes.
8. Press the Clock Function key and the time of the day is shown and the oven is back in manual mode.

# ACCESSORIES

---

Your appliance is equipped with the following accessories:

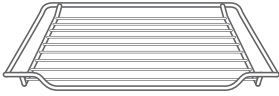

Wire Rack

For ovenware, cake tins and ovenproof dishes. For roasts and grilled food

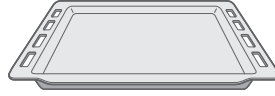

Grill pan: For cooking large quantities of food such as moist cakes, pastries, frozen food etc, or for collecting fat/ spillage and meat juices. This can also be used as a roasting tin and a baking sheet.

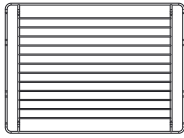

Trivet

## Inserting accessories

To ensure the oven shelves operate safely, correct placement of the shelves between the side rail is imperative. Shelves and the grill pan can only be used between the first and fifth layers.

The shelves should only be used in the right direction as shown in the picture as it ensures that trays and hot food items do not slide if the shelves are moved.

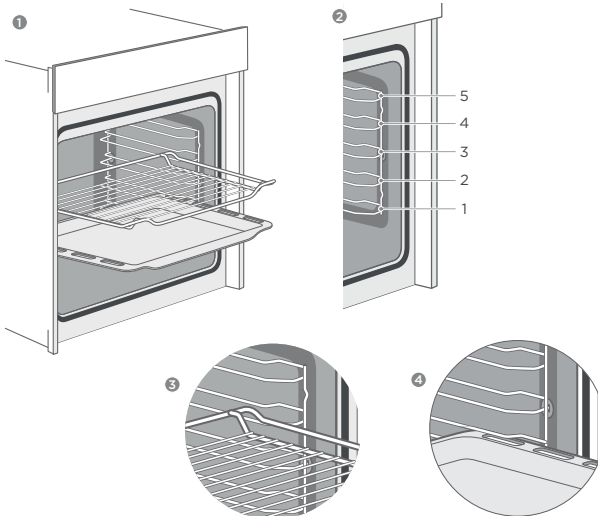

# MAINTAINING YOUR APPLIANCE

---

With good care and cleaning, your appliance will retain its appearance and remain fully functioning for a long time to come. We will explain here how you should correctly care for and clean your appliance.

To ensure that the different surfaces are not damaged by using the wrong cleaning agent, observe the information in the table. Depending on the appliance model, not all of the areas listed may be on/in your appliance.

## CAUTION

### Do not use:

1. Harsh or abrasive cleaning agents.
2. Cleaning agents with a high alcohol content.
3. Hard scouring pads or cleaning sponges.
4. High-pressure cleaners or steam cleaners.
5. Special cleaners for cleaning the appliance while it is hot.

**Wash new sponge cloths thoroughly before use.**

Area Appliance exterior	Cleaning
Appliance exterior Stainless steel front	<b>Hot soapy water:</b> Clean with a dish cloth and then dry with a soft cloth. Remove flecks of limescale, grease, starch and albumin (e.g. egg white) immediately. Corrosion can form under such flecks. Special stainless steel cleaning products suitable for hot surfaces are available from our after-sales service or from specialist retailers. Apply a very thin layer of the cleaning product with a soft cloth.
Plastic	<b>Hot soapy water:</b> Clean with a dish cloth and then dry with a soft cloth. Do not use glass cleaner or a glass scraper.
Painted surfaces	<b>Hot soapy water:</b> Clean with a dish cloth and then dry with a soft cloth.
Control panel	<b>Hot soapy water:</b> Clean with a dish cloth and then dry with a soft cloth. Do not use glass cleaner or a glass scraper.
Door panels	<b>Hot soapy water:</b> Clean with a dish cloth and then dry with a soft cloth. Do not use a glass scraper or a stainless steel scouring pad.
Door handle	<b>Hot soapy water:</b> Clean with a dish cloth and then dry with a soft cloth. If descaler comes into contact with the door handle, wipe it off immediately. Otherwise, any stains will not be able to be removed.
Enamel surfaces and self-cleaning surfaces	Observe the instructions for the surfaces of the cooking compartment that follow the table.

Area Appliance exterior	Cleaning
Glass cover for the interior lighting	<b>Hot soapy water:</b> Clean with a dish cloth and then dry with a soft cloth. If the cooking compartment is heavily soiled, use oven cleaner.
Door seal Do not remove	<b>Hot soapy water:</b> Clean with a dish cloth. Do not scour.
Stainless steel door cover	Stainless steel cleaner: Observe the manufacturer's instructions. Do not use stainless steel care products. Remove the door cover for cleaning.
Accessories	<b>Hot soapy water:</b> Soak and clean with a dish cloth or brush. If there are heavy deposits of dirt, use a stainless steel scouring pad.
Rails	<b>Hot soapy water:</b> Soak and clean with a dish cloth or brush.
Pull-out system	<b>Hot soapy water:</b> Clean with a dish cloth or a brush. Do not remove the lubricant while the pull-out rails are pulled out. It is best to clean them when they are pushed in. Do not clean in the dishwasher.
Meat thermometer	<b>Hot soapy water:</b> Clean with a dish cloth or a brush. Do not clean in the dishwasher.

## Notes

1. Slight differences in color on the front of the appliance are caused by the use of different materials, such as glass, plastic and metal.
2. Shadows on the door panels, which look like streaks, are caused by reflections made by the interior lighting.
3. Enamel is baked on at very high temperatures. This can cause some slight color variation. This is normal and does not affect operation. The edges of thin trays cannot be completely enameled. As a result, these edges can be rough. This does not impair the anti-corrosion protection.
4. Always keep the appliance clean and remove dirt immediately so that stubborn deposits of dirt do not build up.

## Tips

1. Clean the cooking compartment after each use. This will ensure that dirt cannot be baked on.
2. Always remove flecks of lime scale, grease, starch and albumin (e.g. egg white) immediately.
3. Remove flecks of food with sugar content immediately, if possible, when the fleck is still warm.
4. Use suitable ovenware for roasting, e.g. a roasting dish.

## REMOVING THE APPLIANCE DOOR

1. Open the appliance door fully.
2. Fold open the two locking levers on the left and right
3. Close the appliance door as far as it goes without additional force.
4. Hold the door with one hand on each side. Lift up and slowly pull the door out from the oven.

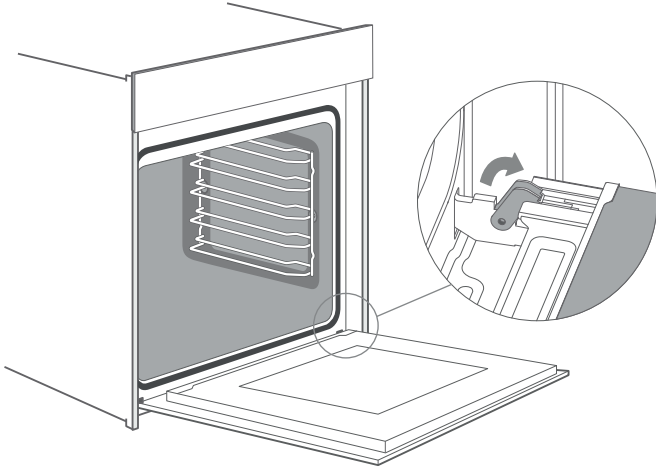

## Removing the door cover

1. Press on the right and left side of the cover.
2. Remove the cover.
3. After removing the door cover , that rest parts of the appliance door can be easily taken ff so that you can go on with the cleaning . When the cleaning of the appliance door has finished , put the cover back in place and press on it until it clicks audibly into place.
4. Fitting the appliance door and close it.
5. To clean the inner layer of glass, locate the catch on the left and right side of the door.
6. Press on them together to release the cover. Remove the middle layer of glass for cleaning.

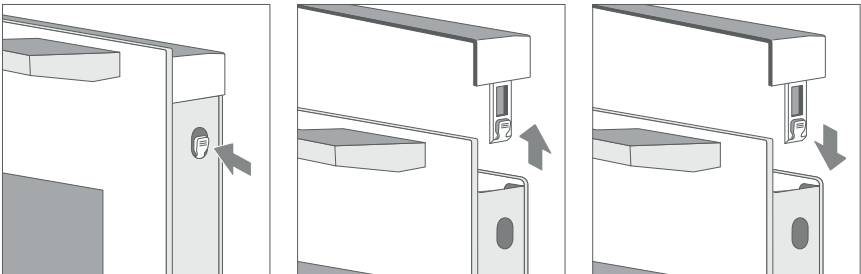

## Fitting the appliance door

To reattach the oven door, follow the sequence above in reverse.

1. Fit the door cover back in its place and press on it until it gives an audible click.
2. Ensure the hinges are inserted into its correct position. You must be able to insert them easily and without resistance.
3. Open the appliance door fully. If the fitting was done incorrectly, the door will not be able to open fully.
4. Close the appliance door and check that the ventilation slots are not concealed.

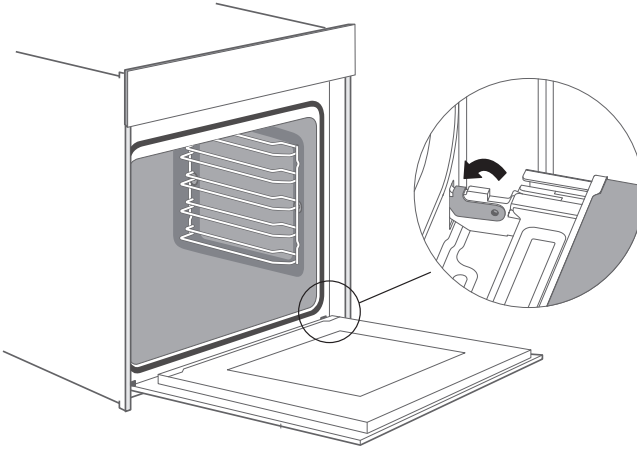



# RAILS

1. Pull the front part of the side rails horizontally to the opposite direction until the feature ❶ gets out ; Later on you can remove the shelves out like the picture below.
2. To put the side rails back to the cavity, to make the back part of the shelves insert into the holes of cavity rightly first of all , then insert the feature ❶ back into the cavity.

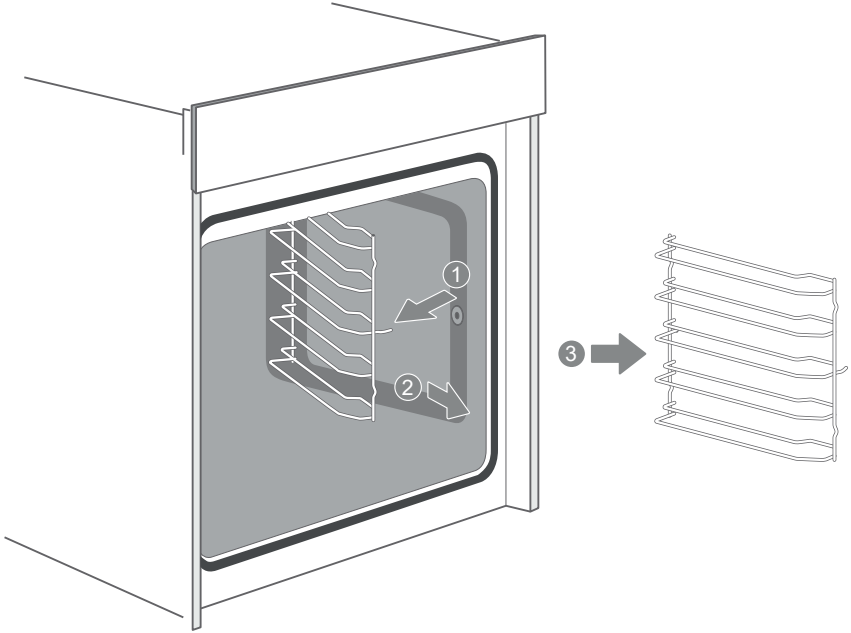

# TROUBLESHOOTING

In any cases not included in this table please contact Customer Care.

Fault	Possible Cause	Notes/remedy
The appliance does not work.	Faulty fuse.	Check the circuit breaker in the fuse box.
	Power cut	Check whether the kitchen light or other kitchen appliances are working.
Knobs have fallen out of the support in the control panel.	Knobs have been accidentally disengaged.	Knobs can be removed. Simply place knobs back in their support in the control panel and push them in so that they engage and can be turned as usual.
Knobs can no longer be turned easily.	There is dirt under knobs	Knobs can be removed. To disengage knobs, simply remove them from the support. Alternatively, press on the outer edge of knobs so that they tip and can be picked up easily. Carefully clean the knobs using a cloth and soapy water. Dry with a soft cloth. Do not use any sharp or abrasive materials. Do not soak or clean in the dishwasher. Do not remove knobs too often so that the support remains stable
Fan does not work all the time in the mode: "Fan Heating"		This is a normal operation due to the best possible heat distribution and best possible performance of the oven.
After a cooking process a noise can be heard and a air flow in the near of the control panel can be observed.		The cooling fan is still working, to prevent high moisture conditions in the cavity and cool down the oven for your convenience. The cooling fan will switch of automatically.
The food is not sufficiently cooked in the time given by the recipe .		A temperature diferent from the recipe is used. Double check the temperatures. The ingredient quantities are diferent to the recipe. Double check the recipe.
Uneven browning		The temperature setting is too high, or the shelf level could be optimized. Double check the recipe and settings. The surface finish and or color and or material of the baking ware were not the best choice for the selected oven function. When use radiant heat, such as "Top & Bottom Heating" mode, use mat finished, dark colored and light weighted oven ware.
The lamp doesn't turn on		The lamp needs to be replaced.

## WARNING-Risk of electric shock!

Incorrect repairs are dangerous. Repairs may only be carried out and damaged power cables replaced by one of our trained after-sales technicians. If the appliance is defective, unplug the appliance from the mains or switch off the circuit breaker in the fuse box. Contact the after-sales service.

## Maximum operating time

The maximum operating time of this appliance is 9 hours, to prevent that you forget shot off the power.

# REPLACING THE LAMP ON THE CORNER OF THE CAVITY

If the cavity lamp fails, it must be replaced. Heat-resistant, 25 watt, 230 V halogen lamps are available from the after-sales service or specialist retailers.

When handling the halogen lamp, use a dry cloth. This will increase the service life of the lamp.

## WARNING

### Risk of electric shock!

When replacing the lamp, the lamp socket contacts are live. Before replacing the lamp, unplug the appliance from the mains or switch other circuit breaker in the fuse box.

### Risk of burns!

The appliance becomes very hot. Never touch the interior surfaces of the appliance or the heating elements. Always allow the appliance to cool down. Keep children at a safe distance.

1. Place a towel in the cold cavity to prevent damage.
2. Turn the glass cover anti-clockwise to remove it (Corner lamp); Pull the lateral grid out and then pry the glass cover off slightly by a tool with a flat head (Lateral lamp).
3. Pull out the lamp – do not turn it.
4. Assemble the glass cover back in.
5. Remove the towel and switch on the circuit breaker to see if lamp switches on.
6. For the lateral lamp, if it works well after the replacement , please remember to put the lateral grid back.

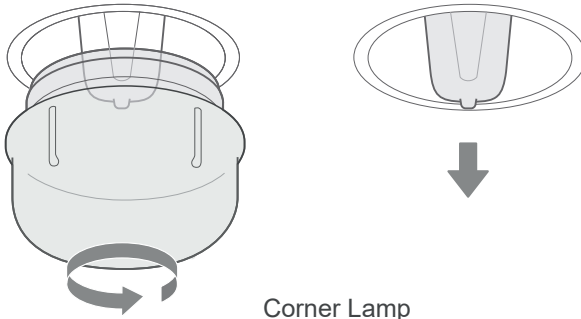

## DATASHEET (EU 65/2014 & EU 66/2014)

---

<b>BEL BI603MF</b>	
No of Cavities	1
Heat Source	Electric
Usable Volume	72L
EElectric, cavity (Conventional)	0.93kWh/cycle
EElectric, cavity (Forced Air)	0.78kWh/cycle
EECavity	91.5
Energy Efficiency Class (A+++ to D)	A

**For the specific power rating of your model, refer to the data badge on the front frame of your appliance.**

**WARNING:** This appliance must be earthed.

-	Symbol	Value	Unit
Model identification	-	BI603MF	-
Type of oven	-	Built-in electric oven	-
Mass of appliance	-	35.2	-
Number of cavities	-	1	-
Heat source per cavity (electricity or gas)	Electricity	-	-
Volume per cavity	V	72	L
Energy consumption (electricity) required to heat a standardised load in a cavity of an electric heated oven during a cycle in conventional mode per cavity (electric final energy)	EC electric cavity	0.93	kWh/cycle
Energy consumption required to heat a standardised load in a cavity of an electric heated oven during a cycle in fan-forced mode per cavity (electric final energy)	EC electric cavity	0.78	kWh/cycle
Energy Efficiency Index per cavity	EEl cavity	91.5	-
Energy efficiency class	-	A	-
1kWh/cycle= 3.6MJ/cycle			

The measurement and calculation method of the above table was done in accordance with commission regulation (EU) No 65/2014 & 66/2014.





# Customer Care

Please keep this handbook in a safe place as the information inside may be of use should you sell, or pass on the appliance. Please fill in the model number and serial number in the spaces provided below as they will assist us should you need to call.

## 0344 815 3746

When you dial this number, you will hear a recorded message and be given several options. This indicates that your call has been accepted and is being held in a queue. Calls are answered in strict rotation as our Customer Care representatives become available.

Enter appliance numbers here for future reference:

<b>Model No</b>									
4	4	4							
<b>Serial No</b>									

These numbers can be found on your appliances data badge. Outside the UK and Northern Ireland, refer to your local supplier.



Stoney Lane, Prescot, Merseyside, L35 2XW.