



**belling**







**SANDRINGHAM - COOKCENTRE - FARMHOUSE**

User manual - EC (90 cm)

## COUNTRIES OF DESTINATION:

GB - Great Britain	<input checked="" type="checkbox"/>
IE - Ireland	<input checked="" type="checkbox"/>
DE - Germany	<input type="checkbox"/>
ES - Spain	<input type="checkbox"/>
FR - French	<input type="checkbox"/>
IT - Italy	<input type="checkbox"/>
PL - Poland	<input type="checkbox"/>
NL - Netherlands	<input type="checkbox"/>
SE - Sweden	<input type="checkbox"/>
CN - China	<input type="checkbox"/>
NZ - New Zealand	<input type="checkbox"/>
AU - Australia	<input type="checkbox"/>

## TO CONTACT BELLING ABOUT YOUR APPLIANCE, PLEASE CALL:

	<b>Customer Care Helpline</b> 0344 815 3746 In case of difficulty within the UK
	<b>Warranty Registration</b> 0800 952 1068 *Please call our Customer Care team for extended warranty
	<b>Spares Store</b> 0344 815 3745
	To register your appliance online: <a href="http://www.belling.co.uk">www.belling.co.uk</a>
	To contact us by email: <a href="mailto:gdhainfo@gdha.com">gdhainfo@gdha.com</a>
	To register your appliance by mail: Please complete the warranty card and return to the address supplied
	Alternatively general, spares and service information is available from our website at: <a href="http://www.belling.co.uk">www.belling.co.uk</a>

Calls are charged at the basic rate, please check with your telephone service provider for exact charges

Your new appliance comes with our 12-month guarantee (UK only), protecting you against electrical and mechanical breakdown. To register, please complete the registration form included, register online or by phone. For full terms & conditions of the manufacturer's guarantee, please refer to the website above. In addition, you may wish to purchase an extended warranty. A leaflet explaining how to do this is included with your appliance.

Our policy is one of constant development and improvement, therefore we cannot guarantee the strict accuracy of all of our illustrations and specifications. Changes may have been made subsequent to publishing.

**Glen Dimplex Home Appliances, Stoney Lane,  
Prescot, Merseyside, L35 2XW**



## **CONTENTS**

INTRODUCTION	4
SAFETY	5
GETTING TO KNOW YOUR PRODUCT	7
USING YOUR APPLIANCE	9
USING THE HOB	10
USING THE GRILL	11
USING THE MAIN OVEN - FANNED	12
COOKING GUIDE	15
BAKING GUIDE	16
ROASTING GUIDE	20
CLOCK/PROGRAMMER	21
REMOVING SHELF RUNNERS	25
CLEANING YOUR APPLIANCE	26
TECHNICAL DATA	27

# INTRODUCTION

---

Thank you for buying this British-built appliance from us.

This user guide book is designed to help you through each step of owning your new product.

Please read it carefully before you start using your appliance, as we have endeavored to answer as many questions as possible, and provide you with as much support as we can.

General information, spares and service information is available from our website.

If you should find something missing from your product or have any questions that are not covered in this user guide, please contact us (see contact information inside the front cover).

## EUROPEAN DIRECTIVES

As a producer and a supplier of cooking appliances we are committed to the protection of the environment and are in compliance with the WEEE directive. All our electric products are labelled accordingly with the crossed out wheeled bin symbol. This indicates, for disposal purposes at end of life, that these products must be taken to a recognized collection points, such as local authority sites/local recycling centres.

This appliance Complies with European Community Directives (CE) for household and similar electrical appliances and Gas appliances where applicable.

This appliance conforms to European Directive regarding Eco design requirements for energy-related products. Our policy is one of constant development and improvement, therefore we cannot guarantee the strict accuracy of all of our illustrations and specifications – changes may have been made subsequent to publishing.

## DISPOSAL OF PACKAGING MATERIAL



The packaging materials used with this appliance can be recycled. Please dispose of the packaging materials in the appropriate container at your local waste disposal facilities.





## SAFETY

---

### WARNING

- ⚠ Never put items directly on the base of the oven or cover the oven with foil, as this can cause the base element to overheat.
- ⚠ Accessible parts may become hot when the grill is in use. Children should be kept away
- ⚠ Do not place articles on or against the appliance.
- ⚠ Always switch off your appliance and allow it to cool down before you clean any part of it.
- ⚠ Although every care has been taken to ensure this appliance has no sharp edges, we recommend that you wear protective gloves when installing and moving this appliance. This will prevent injury.
- ⚠ This appliance must be fitted to a switch providing all pole disconnection with a minimum contact separation of 3mm.
- ⚠ Connection should be made with a suitable flexible cable with a minimum temperature of 70°C.
- ⚠ Do not use a steam cleaner on any cooking range, hob or oven appliance.
- ⚠ If your appliance is fitted with a lid, any spillage should be removed from the lid before opening. The hob surface should be allowed to cool before closing the lid (if fitted).
- ⚠ To avoid electric shock, ensure that the appliance is switched off before replacing the lamp.
- ⚠ The appliance is not intended to be operated by means of an external timer or separate control system.
- ⚠ Unattended cooking on a hob with fat or oil can be dangerous and may result in fire.
- ⚠ NEVER try to extinguish a fire with water, but switch off the appliance and then cover the flame with a lid or damp cloth.
- ⚠ Danger of fire: Do not store items on the cooking surfaces.
- ⚠ Only use hob guards designed by the manufacturer of the cooking appliance or indicated by the manufacturer of the appliance in the instructions for use as suitable or hob guards incorporated in the appliance. The use of inappropriate hob guards can cause accidents.
- ⚠ If the cooker is placed on a base, measures have to be taken to prevent the appliance slipping from the base.
- ⚠ The cooking process has to be supervised. A short term cooking process has to be supervised continuously.
- ⚠ This appliance must not be installed behind a decorative door in order to avoid overheating.
- ⚠ Ensure shelving is correctly installed. See the sections on the shelf runners and shelf location within this book.
- ⚠ This appliance is for cooking purposes only. It must not be used for other purposes, for example room heating.

## CAUTION

-  If the hob surface is cracked, broken or shattered, switch off the appliance to avoid the possibility of electric shock and call for a service engineer's visit.
-  During use the appliance becomes hot. Care should be taken to avoid touching heating elements.
-  Children less than 8 years of age shall be kept away unless continuously supervised. This appliance can be used by children aged from 8 years and above and persons with reduced physical sensory or mental capabilities or lack of experience and knowledge if they have been given supervision or instruction concerning the use of the appliance in a safe way and understand the hazards involved. Children shall not play with the appliance. Cleaning and user maintenance shall not be made by children without supervision.
-  Do not use harsh abrasive cleaners or sharp metal scrapers to clean the oven door glass or the hob, since they can scratch the surface, which may result in shattering of the glass.

## FIRE SAFETY ADVICE







-  If you do have a fire in the kitchen, don't take any risks – get everyone out of your home and call the Fire Service.

If you have an electrical fire in the kitchen:

1. Pull the plug out, or switch off the power at the fuse box – this may be enough to stop the fire immediately
2. Smother the fire with a fire blanket, or use a dry powder or carbon dioxide extinguisher

-  Remember: never use water on an electrical or cooking oil fire.

## OTHER SAFETY ADVICE

-  Servicing should be carried out only by authorised personnel.
-  Do not operate the appliance without the glass panel correctly fitted.
-  There is a risk of electric shock, so always make sure you have turned off and unplugged your appliance. Always allow the product to cool down before you change a bulb.
-  Do not modify the outer panels of this appliance in any way.
-  This appliance must be earthed.
-  The appliance must never be disconnected from the mains supply during use, as this will seriously affect the safety and performance, particularly in relation to surface temperatures becoming hot and gas operated parts not working efficiently. The cooling fan (if fitted) is designed to run on after the control knob has been switched off.

# GETTING TO KNOW YOUR PRODUCT

**i** Note: Your appliance layout may differ depending on the model.

## HOB

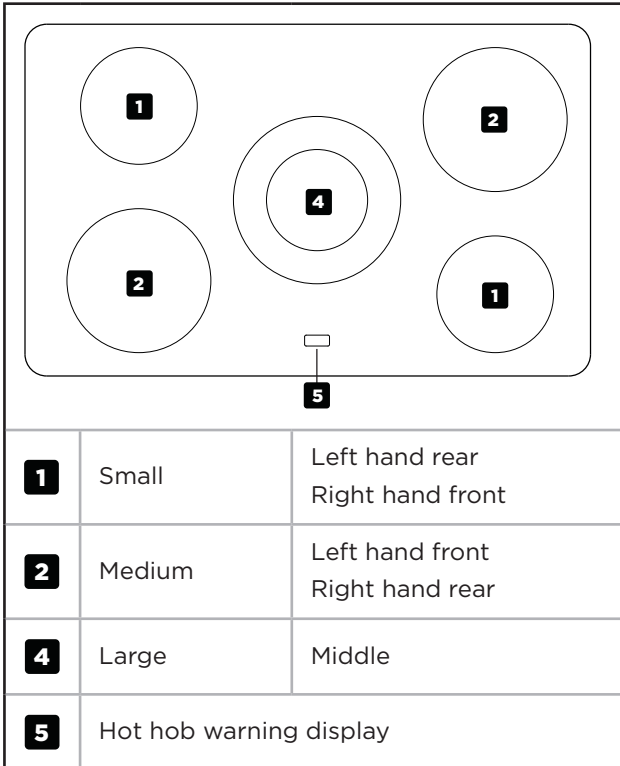

## OVERVIEW

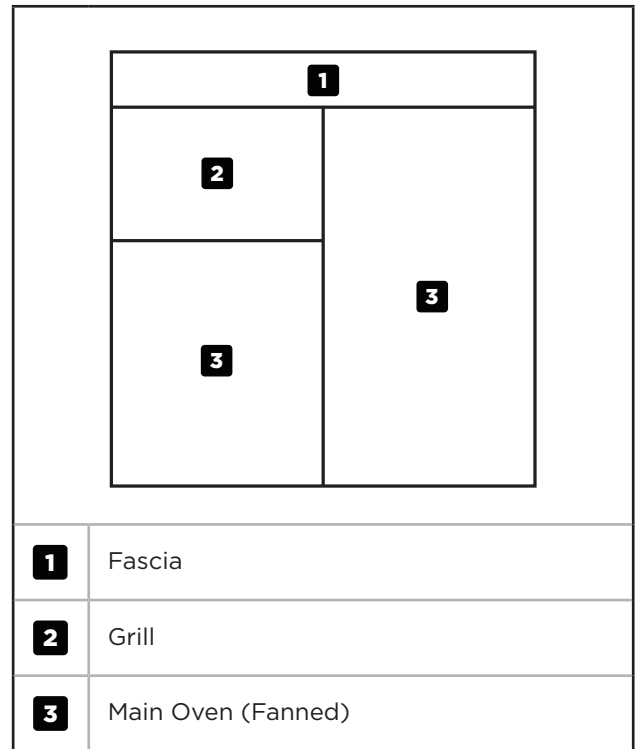

## CONTROL PANEL

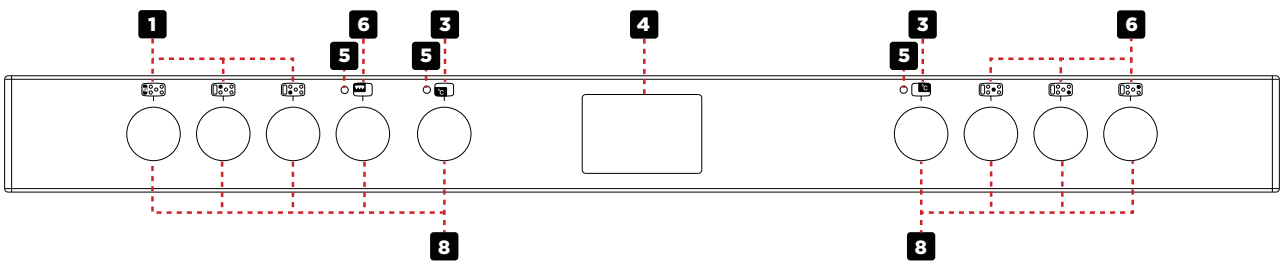

<b>1</b>	Cook Zones	<b>6</b>	Grill
<b>3</b>	Oven	<b>8</b>	Hob and Oven controls
<b>4</b>	Clock/Programmer		
<b>5</b>	Thermostat indicator		

## OVEN CONTROLS

### Oven

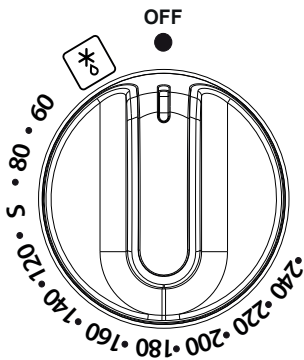

### Top Oven/Grill

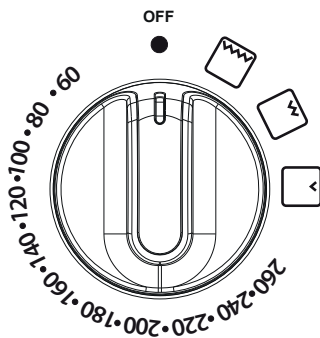

### Single Grill

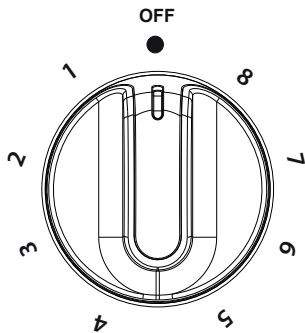

### Dual Grill

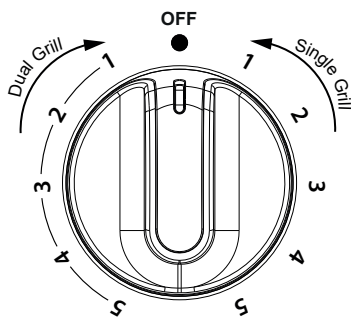

## APPLIANCE FUNCTIONS

**Note:** Your oven may not have all of the functions shown here. We recommend for best cooking results, please preheat your oven for 15 minutes and 3-5 minutes for grilling.

	Intense Baking
	Base Heat with Fan
	Slow Cook
	Fanned Grill
	Oven Selector Control
	Conventional Grill
	Top Heat
	Lights Only
	Defrost
	Conventional oven
	Fanned Oven
	Low Grill
	Single Grill
	Dual Grill
	Base Heat



# USING YOUR APPLIANCE

## OVENS AND GRILL

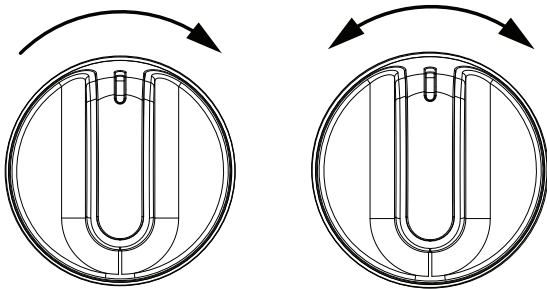
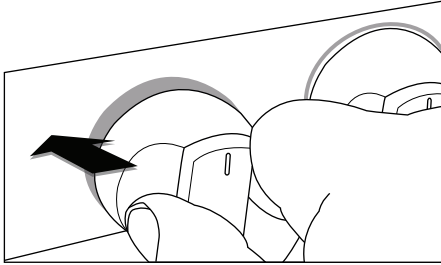

Main Oven

Grill

When using the top oven or main oven, the red thermostat indicator light will come on until the selected temperature is reached.

When the Top oven/grill or grill is switched on, the cooling fans come on to keep the fascia and control knobs cool during cooking/grilling. The cooling fans may operate when the main ovens are in use, depending on the temperature setting. The fans may continue to operate for a period after the oven/grill has been switched off. During use the fan may cycle on and off, this is normal.

**⚠** Important: Never put items directly on top the base of the oven, or cover the oven base with foil, as this may cause the element to overheat. Always position items on the shelf.

**i** The left hand main oven will not operate if the programmer is set to Auto, see Clock/Programmer section.

### Top Oven – Grill

**⚠** The door must be OPEN when the grill is used.

## GRILL PAN, TRIVET AND DETACHABLE GRILL PAN HANDLE

The grill trivet (inside the grill pan) can be inverted to give a high or low position, or it may be removed. The speed of grilling can be controlled by selecting a higher or lower shelf position, or adjusting the grill setting.

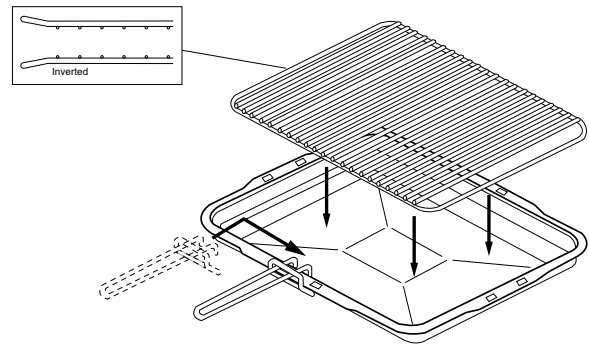

**⚠** The door must be open when the grill is used for conventional grilling.

## HOB

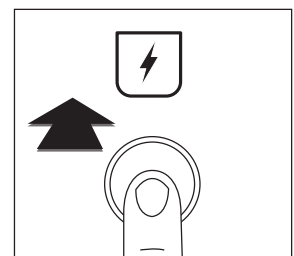
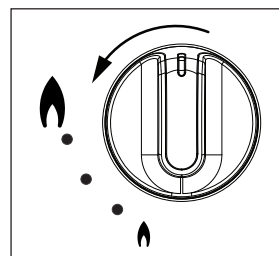
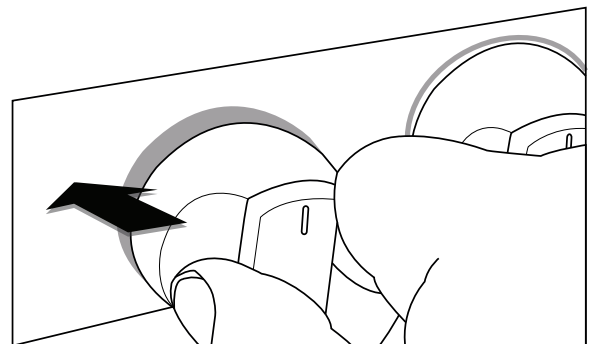

### Hot Hob warning (if fitted)

A light appears on the hob display when the surface becomes hot. This light will illuminate when any cook zone is in use and will remain lit until the surface has cooled down.

## USING THE HOB

---

### SAFETY

- ⚠ Commercial simmering aids should not be used as they create excessive temperatures that can damage the surface and may cause a hazard.
- ⚠ Do not place aluminium foil or plastic utensils on the ceramic glass, as they may melt and damage the surface.
- ⚠ Do not use the ceramic glass hotplate surface for storage.
- ⚠ When cooking with fat or oil, never leave unattended.
- ⚠ Turn pan handles to a safe position, so they are out of reach of children, not overhanging the appliance, and cannot be caught accidentally.
- ⚠ Position pans over the centre of the hotplate elements.
- ⚠ Do not use the hob as a chopping board or a storage area, as this increases the likelihood of it being damaged – e.g.; plastic utensils placed on a warm hob may melt onto it, and damage the ceramic glass surface.
- ⚠ Be careful when cooking foods in salted water, or foods containing large amounts of sugar, syrup or jam – if they are spilled onto hot areas of the hob they may damage it.
- ⚠ Lift pans onto and off the surface, rather than sliding them across the surface, to avoid marks and scratches.
- ⚠ If you use a wet paper towel to remove spills from a warm heating area of the hob, be careful to avoid steam burns.
- ⚠ Do not use abrasive powder cleaners, metal wire wool pads, impregnated plastic pads, detergents, bleaches, bath stain removers, or chemical oven cleaners; all these types of products will damage the ceramic glass.

## USING THE GRILL

---

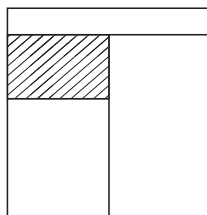

### BEFORE YOU START GRILLING. . . .

Before you use the grill, make sure you have placed the grill shelf in the position you need as once the grill is on you may injure yourself if you try to move the shelf.

- Do not close the door while the grill is in use.
- Turn the top oven control knob to the required grill setting.
- Turn the grill control knob (if fitted) to the heat setting you require.
- To switch off, return the control knob(s) to the 'off' position.
- The cooling fan will come on during use, and may continue to run for some time afterwards.
- To adjust your results, you can turn the grid over, or remove it altogether.
- The dual grill uses all of the top element and is ideal for grilling large quantities of food.
- The single grill uses part of the element only, and is better suited to grill smaller amounts of food.

### THE GRILL PAN

This appliance comes with a grill pan and trivet.

### SHELF & TRIVET ADJUSTMENTS

Speed of grilling can be adjusted by changing the shelf position or the turning the trivet.

- High: For thin foods and toasting
- Low: For thicker meat pieces.

### ALUMINIUM FOIL

**⚠** Never cover the grill pan or grill trivet with foil, or allow fat to build up in the grill pan, as this creates a fire hazard.

**⚠** Accessible parts may become hot when the grill is in use. Children should be kept away

### TYPES OF GRILL

#### THE COOLING FAN

During use the fan may cycle on and off, this is normal.

When the grill is switched on, the cooling fan comes on to keep the fascia and control knobs cool during grilling. The fan may continue to operate for a period after the grill has been switched off.

# USING THE MAIN OVEN - FANNED

---

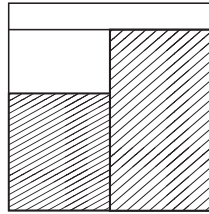

**⚠** Accessible parts may be hot when the oven is used. Young children should be kept away.

## OVEN FURNITURE

### Oven shelves

The oven shelf must be positioned with the upstand at the rear of the oven and facing upwards.

**i** Extra shelves may be ordered from your local supplier.

### Baking tray and roasting tins

For best cooked results and even browning, the recommended size baking trays and roasting tins that should be used are as follows;

- Baking tray 350mm x 250mm

This size of baking tray will hold up to 12 small cakes.

- Roasting tin 370mm x 320mm

**i** Position baking trays and roasting tins on the middle of the shelves, and leave one clear shelf-position between shelves, to allow for circulation of heat.

**i** We recommend that you use good quality cookware. Poor quality trays and tins may warp when heated, leading to uneven baking results.

### Shelf positions

As a general guide, when cooking frozen or chilled food, use the highest possible shelf position, while allowing some clearance between the food and the top element. Follow the instructions given on packaging.

### To help the air circulate freely

Position the shelves evenly within the oven and maintain a clearance from the oven roof and base.

If more than one cooking dish or baking tray is to be used on a shelf, leave a gap of at least 25mm between the items themselves and the oven interior.

### The cooling fan

The cooling fan may operate when the main oven is on and may continue to operate for a period after the oven has been switched off.

### Aluminium Foil

**⚠** Use foil only to cover food or cooking dishes, using foil to cover the shelves or oven base creates a fire hazard.

## WHEN USING THE OVEN

As part of the cooking process, hot air is expelled through a vent at the top of the oven(s). When opening the oven door, care should be taken to avoid any possible contact with potentially hot air, since this may cause discomfort to people with sensitive skin. We recommend that you hold the underneath of the oven door handle.

## To switch on the oven

- Turn the oven control knob(s) to the required setting.

The white thermostat neon (if fitted) will come on until the selected temperature is reached and then go off; it will turn on and off periodically as the thermostat operates to maintain the selected temperature.

- To switch off, return the control knob to the off position.

## Preheating

### Fanned oven

When cooking sensitive items such as soufflé and Yorkshire puddings or, when cooking bread, we recommend that the oven is preheated until the neon switches off for the first time. For any other types of cooking, a preheat may not be required.

### Conventional oven

Preheating is always required

## Manual Operation (Left hand oven only)

The programmer must be set to manual operation before the main oven can be used. If A (Auto) is on the programmer display, return the oven to manual by pressing the plus and minus buttons simultaneously or the Menu button where applicable. Any programme which has been set is cancelled.

## Cooking with a fanned oven

**⚠** As this is a high efficiency oven, you may notice the emission of steam from the oven when the door is opened. Please take care when opening the door.

If you are used to cooking with a conventional oven you will find a number of differences to cooking with a fan oven which will require a different approach:

There are no zones of heat in a fan oven as the convection fan at the back of the oven ensures an even temperature throughout the oven.

This makes it ideal for batch baking – eg; when planning a party as all the items will be cooked within the same length of time.

- i** Foods are cooked at a lower temperature than a conventional oven, so conventional recipe temperature may have to be reduced. Please refer to the conversion chart.
- i** Preheating is generally not necessary as a fan oven warms up quickly.
- i** There is no flavour transference in a fan oven, which means you can cook strong smelling foods such as fish at the same time as mild foods – eg; milk puddings.
- i** When batch baking foods that will rise during cooking – eg; bread – always ensure that enough space has been left between the shelves to allow for the rise.

### Notes:

- i** When 2 or more shelves are being used, it may be necessary to increase the cooking time slightly.
- i** Because the 2 oven shelves are wider than in many ovens, it is possible to cook 2 items per shelf – eg; 2 victoria sandwiches or 2 casseroles.
- i** When roasting meats, you will notice that fat splashing is reduced, which is due in part to the lower oven temperatures, and will help keep cleaning of the oven to a minimum.
- i** Because a fan oven has an even temperature throughout the oven, there is no need to follow the shelf positions given in the baking guide.
- i** There is no need to interchange dishes onto different shelves part way through cooking, as with a conventional oven.

## Keep Warm (Setting or 70°C)

This setting temperature is set to allow the user to keep food warm without over cooking. This setting can also thaw frozen foods, or warm plates.





-  Do not use this as a cooking function.

## Defrosting and cooling in the main oven





To defrost frozen foods, turn the main oven control to the Bread Proving position, place the food in the centre of the oven and close the door.

To cool foods after cooking prior to refrigerating or freezing, turn the main oven control to the defrost position and open the door.

### Defrosting times

-  Small or thin pieces of frozen fish or meat – eg; fish filets, prawns & mince will take approximately 1 – 2 hours.
-  Placing the food in a single layer will reduce the thawing time.
-  A medium sized casserole or stew will take approximately 3 – 4 hours.
-  A 1½kg/3lb oven ready chicken will take approximately 5 hours, remove the giblets as soon as possible.

### Be safe

-  Do not defrost stuffed poultry using this method.
-  Do not defrost larger joints of meat and poultry over 2kg / 4lb using this method.
-  Never place uncooked food for defrosting next to cooked food which is to be cooled, as this can lead to cross contamination.
-  Defrosting meat, poultry, and fish can be accelerated using this method but make sure they are completely thawed before cooking thoroughly. Place meat and poultry on a trivet in a meat tin.

# COOKING GUIDE

---

## GRILL

Food Type	Time Approx (mins)
<b>Bacon</b>	8 - 15
<b>Sausages</b>	12 - 15
<b>Chops</b>	
- Lamb	10 - 15
- Pork	15 - 25
<b>Toast</b>	
- 2 rounds	1 - 2 (per side)
- 4 rounds	1 - 2 (per side)
<b>Bread products</b>	
- Buns	1 - 2 (per side)
- Tea cakes	1 - 2 (per side)
<b>Cheese on toast</b>	
- 2 rounds	4 - 5
- 4 rounds	4 - 5
<b>Fish</b>	
- Fillets	10 - 15
<b>Chicken</b>	
- Fillets	20 - 30
<b>Beef Steaks</b>	
- Rare	7 - 10
- Medium	10 - 15
- Well done	15 - 20
<b>Gammon Steaks</b>	12 - 15

**i** As with any cooking guide, all times are approximate and can be adjusted to suit personal taste.

# BAKING GUIDE

---

## TOP OVEN

### Cooking temperatures

The temperature settings and time given in the Baking Guides are based on dishes made with block margarine. If soft tub margarine is used, it may be necessary to reduce the temperature setting. If a recipe gives a different temperature setting to that shown in the guide, the recipe instruction should be followed.

- i** Because the top oven is more compact, it may be necessary to reduce cooking temperatures specified in recipes by up to 20°C.

- i** Use the baking guide as a reference for determining which temperatures to use.

### Cooking times

- i** These times are based on cooking in a preheated oven.
- i** These cooking times are approximate, due to the size and type of cooking dish and personal preferences.

Item	Temperature (°C)	Shelf Position	Approximate cooking time
Small cakes	160°C - 180°C (fanned)	1	15 - 20 mins
Victoria sandwich (2 x 180mm / 7")	160	1	20 - 25 mins
Swiss roll	200	1	8 - 12 mins
Semi rich fruit cake (180mm x 7")	140	1	2¼ - 2¾ hours
Scones	215	1	10 - 15 mins
Meringues	90 - 100	1	2 - 3 hours
Shortcrust pastry	200 - 210	1	Depends on size & type of cooking dish & also the filling
Puff / flaky pastry	200 - 210	1	
Choux pastry	200 - 210	1	
Biscuits	160 - 200	2	10 - 20 mins
Sponge pudding	150	1	30 - 45 mins
Milk pudding	140	1	2 - 2½ hours



## MAIN OVEN



### Cooking times & temperatures

- i** The temperature settings and times given in the baking guide are based on dishes made with block margarine. If soft tub margarine is used it may be necessary to reduce the temperature setting.
- i** Allow enough space between shelves for food that will rise during cooking.
- i** Do not place items on the oven base as this will prevent air circulating freely.

**i Note:** This is a fanned oven, therefore some adjustment will have to be made to conventional cooking temperatures. The table below shows conventional cooking temperatures, fanned oven temperatures and gas marks. For optimum results, conventional temperatures need to be converted to fanned oven temperatures.

For example, an item which would normally cook at a conventional temperature of 180 °C, will now cook at the fanned oven temperature of 160 °C.

Conventional temperature (°C)	Fanned Oven (°C)	Gas Mark
100	100	1/4
110	110	1/4
130	120	1/2
140	130	1
150	140	2
160	150	3
180 - 190	160	4 - 5
200	170	6
220	180	7
230	190	8
250	200	9

Food Type	Temp. Setting °C		Time Approx.	Shelf Position
				
<b>Cakes</b>				
Small cakes	190	160	15 - 25	2 - 4
Victoria sandwich	180	160	20 - 30	3
Semi rich fruit cake	150	125	2½ - 3 hours	2
Christmas cake	150	125	2½ - 3 hours	2
<b>Puddings</b>				
Bread & butter pudding	170	150	45 - 1 hour	3
Fruit crumble	200	175	40 - 1 hour	3
<b>Miscellaneous</b>				
Yorkshire pudding:				
- large	220	200	40 - 48	4 - 5
- small	220	200	15 - 20	4 - 5
Shortcrust pastry	200	180	depends on filling	4 - 5

## GENERAL BAKING GUIDE

### Traditional fruit cakes

It should be remembered that ovens can vary over time, therefore cooking times can vary, making it difficult to be precise when baking fruit cakes.

It is necessary therefore, to test the cake before removal from the oven. Use a fine warmed skewer inserted into the centre of the cake. If the skewer comes out clean, then the cake is cooked.

- i** Follow the temperatures suggested in the recipe and then adjust accordingly to the conversion table.
- i** Do not attempt to make Christmas cakes larger than the oven can cope with, you should allow at least 25mm (1") space between the oven walls and the tin.
- i** Always follow the temperatures recommended in the recipe.
- i** To protect a very rich fruit cake during cooking, tie 2 layers of brown paper around the tin.
- i** We recommend that the cake tin is not stood on layers of brown paper, as this can hinder effective circulation of air.
- i** Do not use soft tub margarine for rich fruit cakes, unless specified in the recipe.
- i** Always use the correct size and shape of tin for the recipe quantities.

## Trouble-shooting – fruit cakes

Problem	Possible Cause
Fruit sinking to the bottom	Low oven temperature which may cause the cake to take longer to set, allowing the fruit to sink. Or, too much liquid, or raising agent. The fruit may not have been properly washed and dried.
Cake sinking / dipping in the centre	Too much raising agent in the mixture. Too hot, or too cool an oven. Or, not enough liquid or insufficient creaming.
Surface cracks	Too small a tin, or too much mixture in the tin. Too much raising agent in the mix, plus not enough liquid or insufficient creaming. The oven may be too hot.
Hard outer crust with a damp patch inside	Oven too hot, therefore the cake baked too quickly. Too much sugar, or insufficient liquid.
Burnt outside	Oven temperature too high. Oven too small for the size of cake. Insufficient protection around the tin. Cake baked on too high a shelf.
Texture with pronounced holes.	Too much raising agent. Flour unevenly mixed.
Texture too close and cake insufficiently risen.	Not enough raising agent. Not enough liquid. Too cool an oven. Insufficient creaming.
Cake crumbles when cut	Not enough liquid. Baked for too long. Not enough sugar. Too much baking agent.
Too dry	Over baking. Insufficient egg or liquid. Too much raising agent.

## Trouble-shooting – sponge cakes

Problem	Possible Cause
Domed top	Insufficient creaming of mixture. Cake baked on too high a shelf position, or at too high a temperature. Paper liners can cause the outer edge not to rise and the centre to peak.
Hollowed / sunken top	Too much raising agent. Oven temperature too low, or incorrect shelf position. Cake removed from oven before it's cooked. Use of soft tub margarine.
Very pale, but cooked	Oven temperature too low. Baked too low in the oven
Overflowing tin	Tin too small for the amount of mixture

## ROASTING GUIDE

---

The times given in the roasting guide are only approximate, because the size and age of the bird will influence cooking times as will the shape of a joint and the proportion of the bone.

Frozen meat should be thoroughly thawed before cooking. For large joints it is advisable to thaw over night.

Frozen poultry should be thoroughly thawed before cooking. The time required depends on the size of the bird – eg; a large turkey may take up to 48 hours to thaw.

Use of a trivet with a roasting tin will reduce fat splashing and will help to keep the oven interior clean. Alternatively, to help reduce fat splashing, potatoes or other vegetables can be roasted around the meat/poultry.

<b>Cook in main oven at:</b>		<b>Approximate Cooking Time (preheated oven)</b>
<b>160°C - 180°C (fanned)</b>		
<b>180°C - 200°C (conv.)</b>		
Beef	Rare	20 minutes per 450g (1lb), plus 20 minutes
	Medium	25 minutes per 450g (1lb), plus 25 minutes
	Well done	30 minutes per 450g (1lb), plus 30 minutes
Lamb	Medium	25 minutes per 450g (1lb), plus 25 minutes
	Well done	30 minutes per 450g (1lb), plus 30 minutes
Pork		35 minutes per 450g (1lb), plus 35 minutes
Poultry		20 minutes per 450g (1lb), plus 20 minutes

**Notes:**

- i** When cooking stuffed meat or poultry calculate the cooking time from the total weight of the meat plus the stuffing.
- i** For joints cooked in foil or covered roasters, and for lidded casseroles, add 5 minutes per 450g (1lb) to the calculated cooking time.

- i** Smaller joints weighing less than 1.25kg (2½lb) may require 5 minutes per 450g (1lb) extra cooking time.
- i** Position the oven shelf so that the meat or poultry is in the centre of the oven.
- i** It is recommended that the appliance is cleaned after open roasting.

### ROAST TURKEY

Roasting turkey involves cooking two different types of meat – the delicate light breast meat, which must not be allowed to dry out, and the darker leg meat, which takes longer to cook.

The turkey must be roasted long enough for the legs to cook, so frequent basting is necessary. The breast meat can be covered once browned.

To test if the turkey is cooked, push a fine skewer into the thickest part of the thigh. If the juices run clear, the turkey is cooked. If the juices are still pink, the turkey will need longer cooking.

- i** Always make sure that the turkey is completely thawed and that the giblets are removed before cooking.
- i** Turkey should be roasted at gas mark 5 for 20 minutes per lb, plus 20 minutes, unless packaging advises otherwise.
- i** The turkey can be open roasted, breast side down, for half of the cook time, and then turned over for the remainder of the cooking time.
- i** If the turkey is stuffed, add 5 minutes per 1lb to the cooking time.
- i** If roasting turkey covered with foil, add 5 minutes per 1lb to the cooking time.
- i** **Please note:** for all other Roasting guides refer to main oven section and see table.

# CLOCK/PROGRAMMER

- i** Please be aware that only the main oven is controlled by the programmer.
- i Note:** Your clock / programmer may not have all these functions

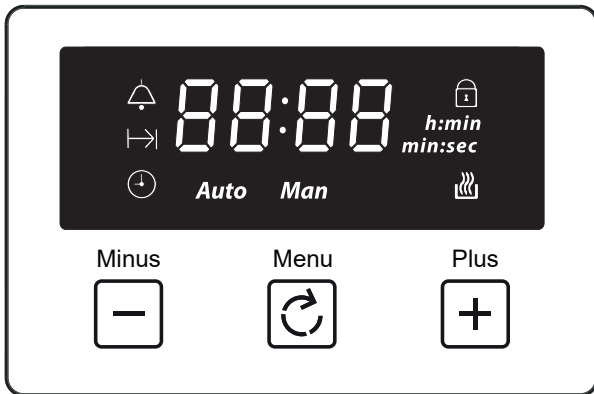

	Minute minder
	Cooking time / Duration
	Time of day
	Key Lock
	Auto cooking
<b>Auto</b>	Automatic mode
<b>Man</b>	Manual mode
L 11.21.3	Volume level
23:59	7-segment display
99:00	Max. adjustable minute minder
2:59	Max. adjustable cooking time
<b>h:min</b>	Display hours:minutes
<b>min:sec</b>	Display minutes:seconds

## USING THE TOUCH CONTROLS

- Menu – Scroll through to select a function
- Plus – Increase time or volume
- Minus – Decrease time or volume

- i** When a function is selected and the time or volume is set, the chosen function will automatically start seven seconds after setting.

## MANUAL MODE

If the programmer is not in semi-automatic or full-automatic mode you can use oven functions manually. The manual icon is also on the display.

## SETTING THE TIME OF DAY

By pressing menu, scroll through the functions until you reach 'time of day'.

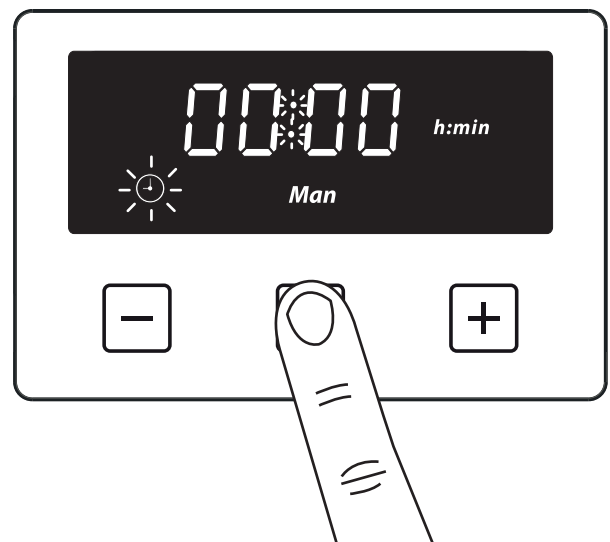

1. Press the function button until the 'time of day' symbol appears

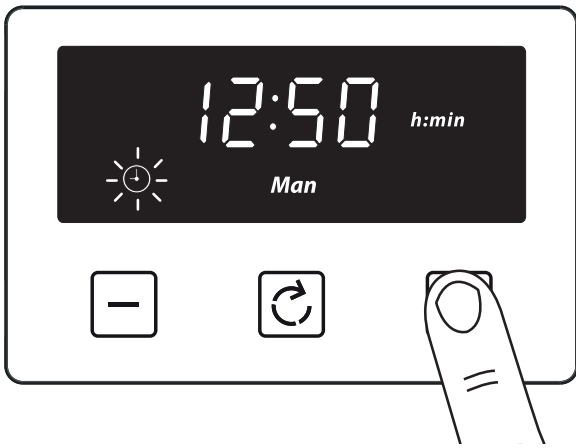

2. Press the plus or minus buttons to set a time

### SETTING THE MINUTE MINDER

The maximum cooking time that can be set is 99 minutes.

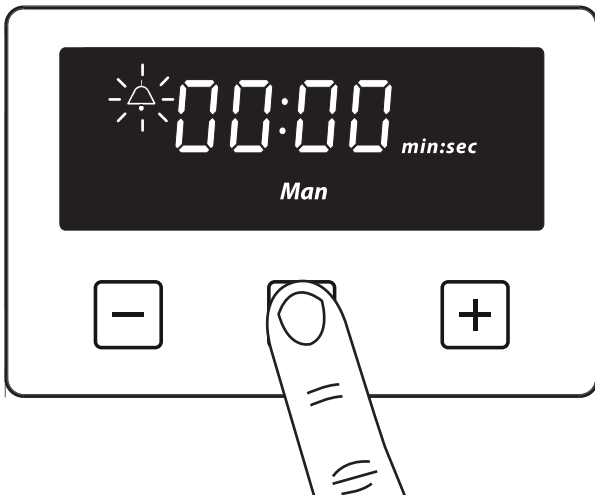

1. Press the function button until the 'minute minder' symbol appears

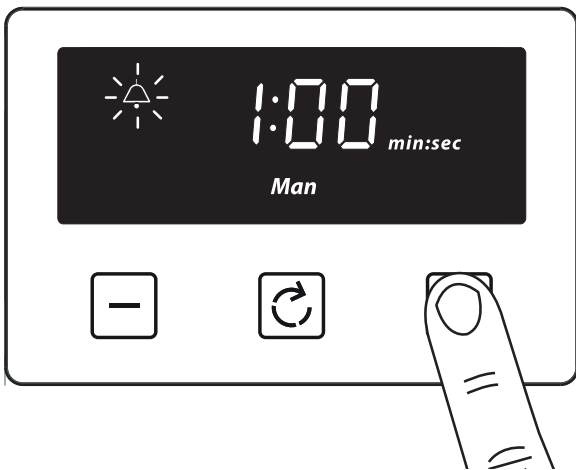

2. Press the plus or minus buttons to set a time

Once set, the minute minder will start to countdown in steps of seconds. The display will show the minute minder symbol and the remaining time. The countdown will continue in the background, if other functions are being set.

When the set time for the minute minder has completed, an alarm is heard and the minute minder symbol will flash on the display. Press any button to stop the alarm and the time of day is displayed.

### To modify or cancel the minute minder

Return to the minute minder function and use either the plus or minus buttons to adjust the time. By setting the time to '0.00', this will cancel the countdown.

### SETTING THE COOKING TIME (SEMI AUTOMATIC COOKING)

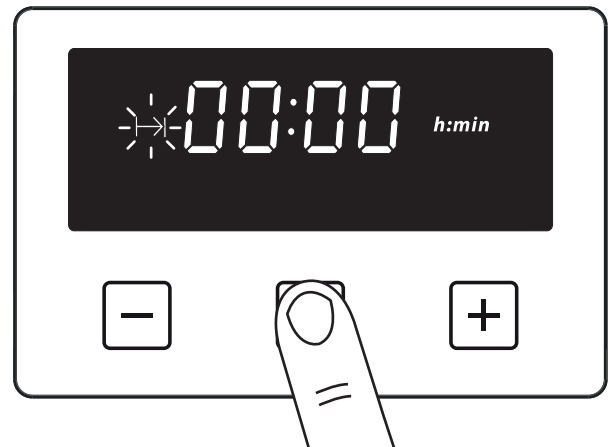

1. Press the function button until the 'cooking time' symbol appears

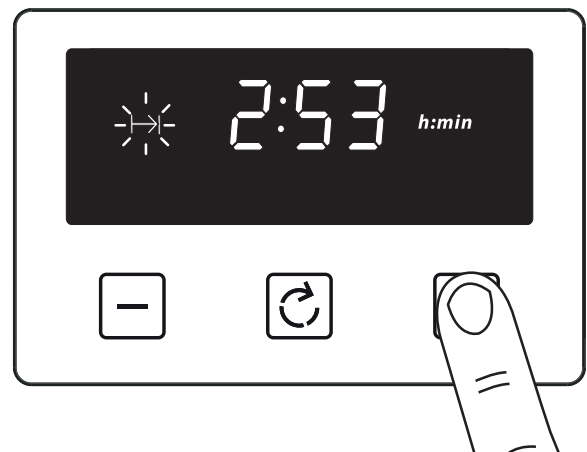

2. Press the plus or minus buttons to set a time

Once set, the automatic mode, auto cooking symbol and the time of day is displayed.

When cooking is completed, an alarm is heard and the manual mode symbol flashes on the display. Press the Menu button to stop the alarm and then the 'time of day' will then be displayed. Pressing the Menu button again will return to manual mode.

- i** Note: Only the bottom left hand oven can use the Semi Automatic cooking function.
- i** The maximum cooking time that can be set is 23 hours and 59 minutes.

### To modify or cancel the cooking time

Return to the 'cooking time' function and use either the plus or minus buttons to set the time. By setting the time to '0.00', this will cancel the countdown.

### SETTING THE END OF COOKING TIME (FULLY AUTOMATIC)



1. Press the function button until the 'end of cooking time' symbol appears

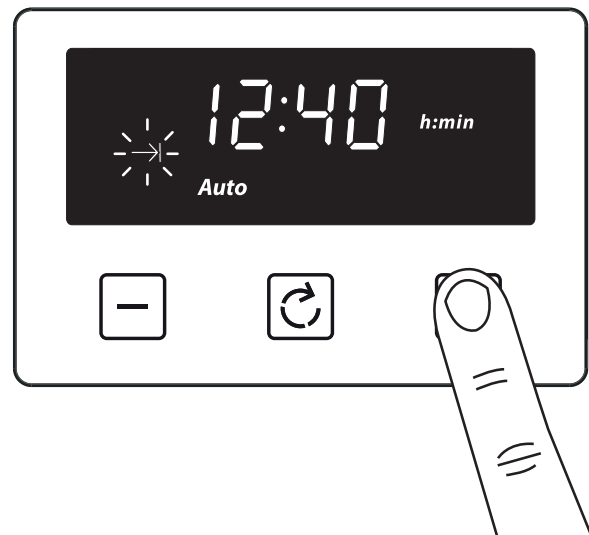

2. Press the plus or minus buttons to set a time

- Enter cooking duration as described in 'Setting the cooking time' section.

The display shows the current 'time of day' plus the 'end of cooking time' symbol. The latest 'end of cooking time' is limited to the current 'time of day' plus the maximum time that can be set (23 hours and 59 minutes).

The auto cooking symbol disappears from the display once the time, the required cooking settings and temperature have been set. The appliance will not be switched on until the set cooking start time, that is the difference between the cooking end time and the cooking duration.

When cooking is completed, an alarm is heard and the manual mode symbol flashes on the display. Press the Menu button to stop the alarm and then the 'time of day' will then be displayed. Pressing the Menu button again will return to manual mode.

### To modify or cancel the end cooking time

Return to the 'end of cooking time' function and use either the plus or minus buttons to set the time. The 'end of cooking time' can be deleted by counting back using the minus button until it equals the current time of day.

## SETTING THE VOLUME

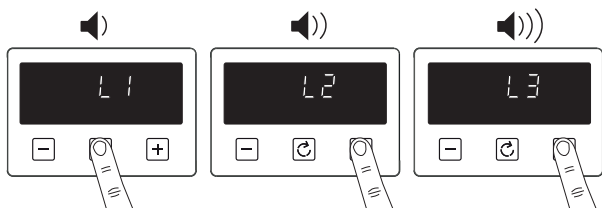

- Press the menu button until “LX” (X = 1, 2 or 3) flashes on the display. Use the plus or minus buttons to select a tone.

**i Note:** Default tone is L3

## ACTIVATING / DEACTIVATING KEY LOCK

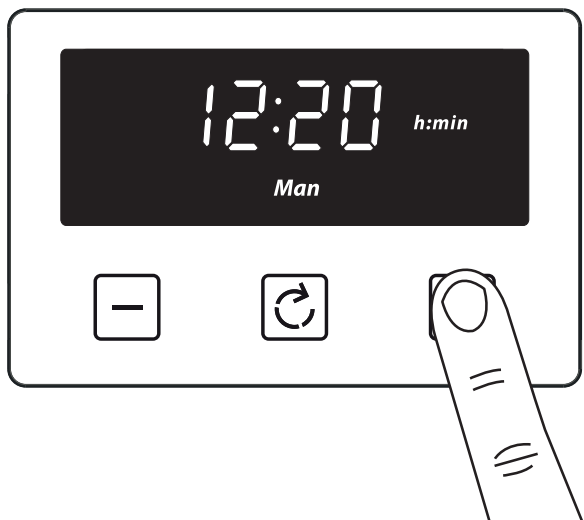

1. Press and hold the plus button for 3–5 seconds



Once the Key lock is active, the buttons will be inactive. A two beep signal will be heard if the buttons are pressed.

## To deactivate the Key lock

- Press and hold the plus button for 3–5 seconds. The Key lock symbol will disappear and the appliance can continue to be used.

- i Note:** In case of main power loss for a short time (about 1.5 minutes), timer maintains its status.
- i** Key lock status and buzzer tone are memorized independent of the power loss duration.



# REMOVING SHELF RUNNERS

## REMOVING SHELF RUNNERS

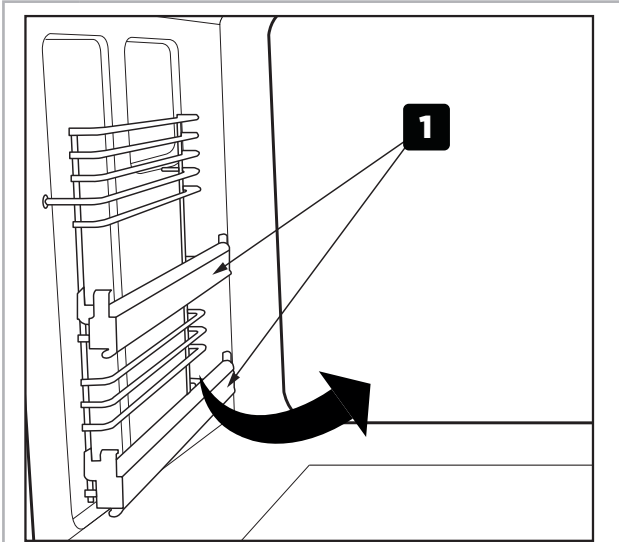

**1** Telescopic positions (if fitted)

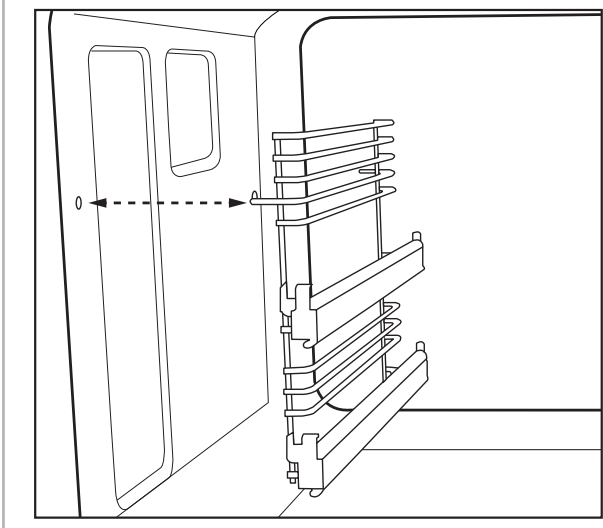

## STANDARD SHELVES

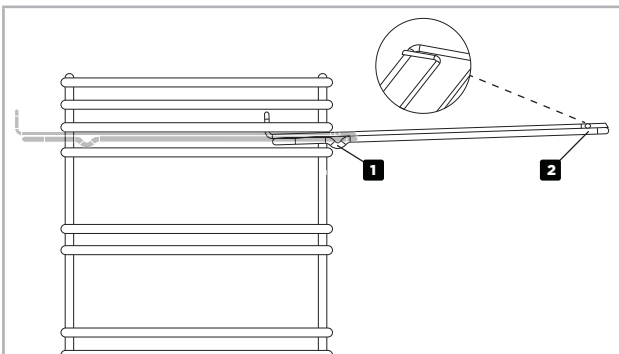

Front of appliance

1. Slightly raise the shelf and insert in the chosen shelf position
2. Ensure the shelf is fully pushed back towards the back of the oven, until the shelf stopper is reached.

## REMOVING TELESCOPIC SHELVES (IF FITTED)

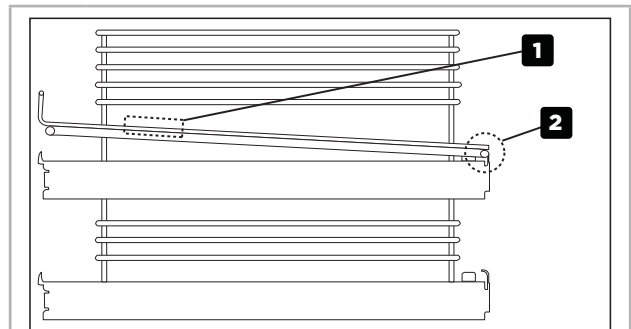

### Front of appliance

- 1** Grasp and lift shelf
- 2** Lift shelf from the retaining tabs

- i** Before removing the shelves completely, please make sure that the shelf is unclipped from the retaining tabs.

## CHANGING THE LIGHT BULB

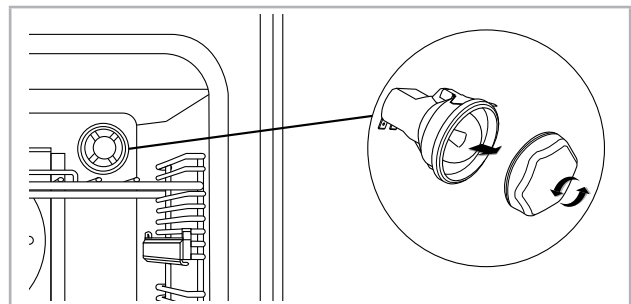

- ⚠ Warning!** Switch off the power before you change the light bulb.

- i** Not all appliances have the same number and type of bulbs. Before you replace your bulb, check to see what type you have. Please remember that bulbs are not covered by your warranty.

# CLEANING YOUR APPLIANCE

## DO'S

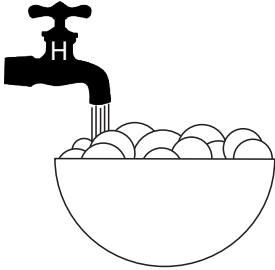

- Warm, soapy water



- Clean, wrung out cloth

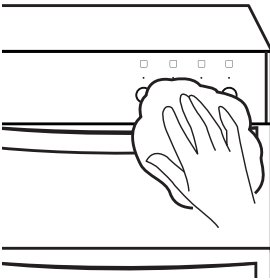

- Wipe with damp cloth
- Dry with a soft cloth

- i** **Note:** Always switch off your appliance and allow it to cool down before you clean any part of it.
- i** **Note:** Please take extra care when cleaning over the symbols on the control panel, as this can lead to them fading.
- i** **Tips:** Some foods can mark or damage the metal or paint work e.g.; Vinegar, fruit juices and salt. Always clean food spillages as soon as possible.

## DON'TS

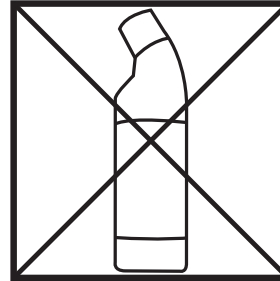

- Undiluted bleaches
- Chloride products

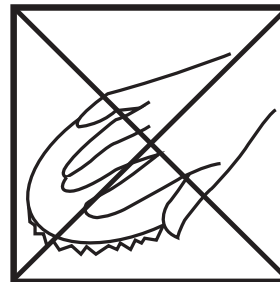

- Wire Wool
- Abrasive cleaners
- Nylon pads
- Steam cleaners

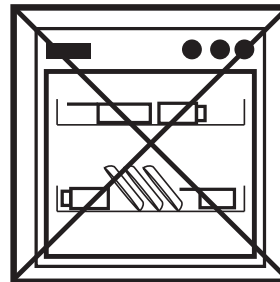

Do not place in the dishwasher:

- Cast iron griddle
- Pan supports

- !** It is important to clean your appliance regularly as a build up of fat can affect its performance or damage it and may invalidate your guarantee.
- !** In addition to the above, do not use metal scrapers to clean the oven door glass.
- i** We offer a great range of cleaning products and accessories for your appliance. To shop, please visit our website located at the front of this User Guide.

# TECHNICAL DATA

---

## ELECTRICAL RANGE

### Hob top

Electrical supply	Hotplate	Zone	Load (kW)
240 V	Ceramic	Small	1.20
		Large	1.70
		Dual zone	0.75 / 2.20

### Appliance

Electrical supply	Oven	Load (kW)
240 V	Fanned	2.0
	Single variable grill	1.85
	Dual variable grill	1.7 / 2.7
	Conventional top	1.39

Model	Electrical supply	Max. load (kW)
Single Grill	240 V	14.48
Dual Grill		15.33

Electrical components	Load
Lamps	25 W each
Cooling fans	10 W each
Oven stir fans	30 W each

[WWW.BELLING.CO.UK](http://WWW.BELLING.CO.UK)



Stoney Lane, Prescott, Merseyside L35 2XW

[belling.co.uk](http://belling.co.uk)

**Customer Care**

0344 815 3740

**Product Information Helpline**

0344 248 4149